

-  Clean water
-  Domestic use
-  Civil use
-  Industrial use

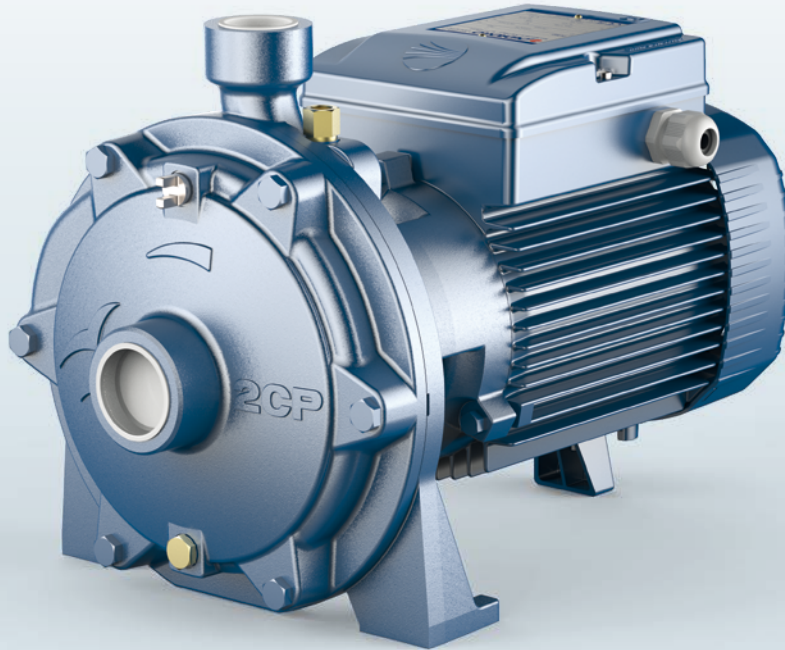

### PERFORMANCE RANGE

- Flow rate up to **450 l/min** (27 m<sup>3</sup>/h)
- Head up to **112 m**

### INSTALLATION AND USE

They are recommended for pumping clean water and liquids that are chemically non-aggressive for the pump materials.

Its high efficiency and adaptability to a wide variety of applications make it an ideal choice in the domestic, civil and industrial sectors, particularly for water distribution in conjunction with autoclave tanks, for increasing network pressure, and for fire-fighting units.

### ELECTRIC MOTOR

The three-phase pumps are equipped with newly developed electric motors designed to work with inverters, which guarantee stable and quiet operation.

Efficiency class **IE3** for three-phase motors and **IE2** for single-phase motors, with class F insulation and IPX4 protection.

### APPLICATION LIMITS

- Manometric suction head up to **7 m**
- Liquid temperature between from **-10 °C** and **+90 °C**
- Ambient temperature between **-10 °C** and **+40 °C**
- Maximum working pressure **10 bar**

### AVAILABLE UPON REQUEST

- ✘ Mechanical seal options available
- ✘ Different voltage requirements 60 Hz frequency
- ✘ IPX5 protection for:
  - 2CP32/200    – 2CP40/180
  - 2CP32/210    – 2CP40/200

**CURVES AND PERFORMANCE DATA – HS=0 m**

**50 Hz**

**2CP 25/14**

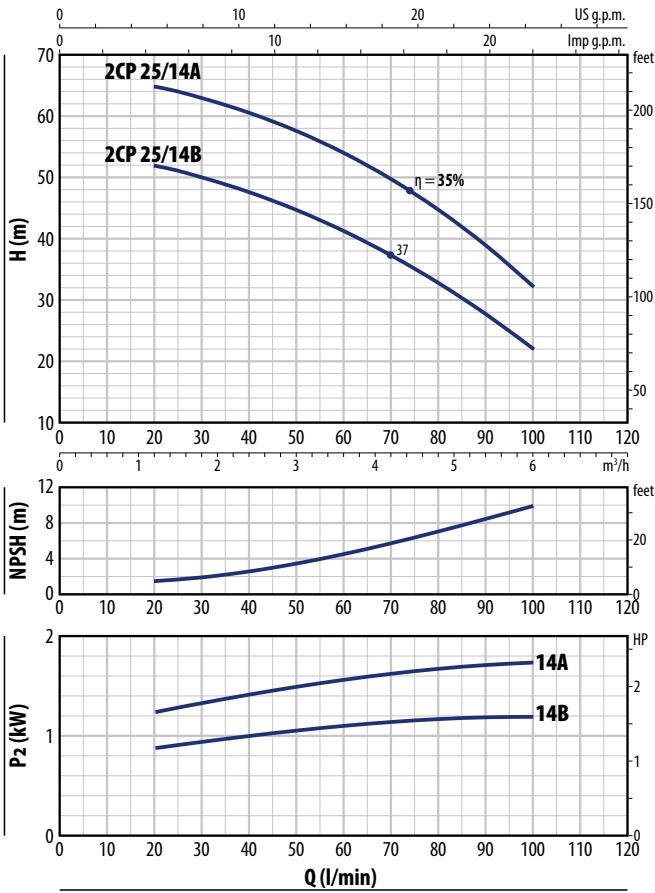

**2CP 25/16**

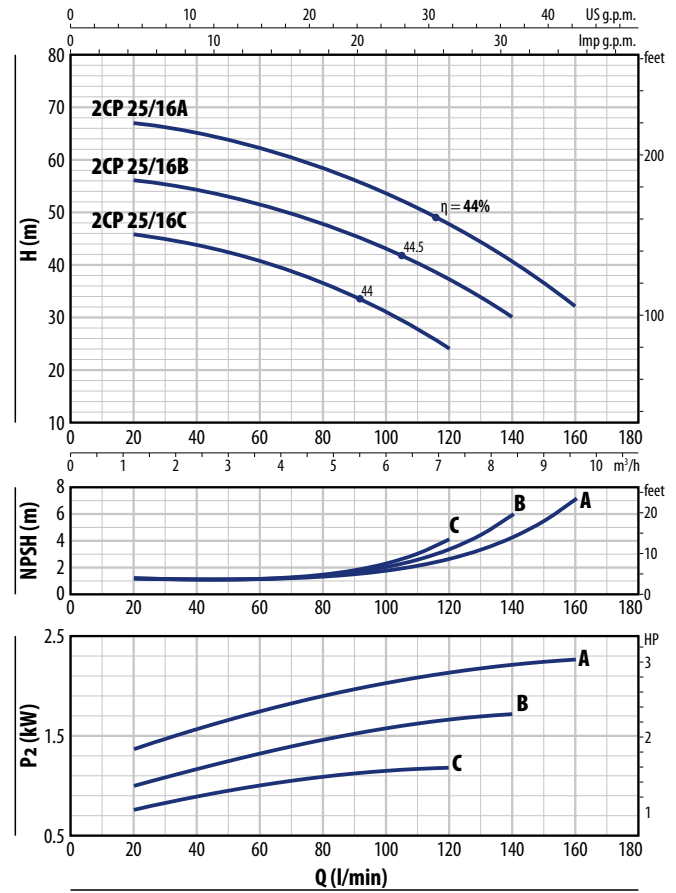

**2CP 25/14**

TYPE		POWER (P <sub>2</sub> )		1~3~	Q	m <sup>3</sup> /h									
Single-phase	Three-phase	kW	HP			l/min	0	1.2	1.8	2.4	3	3.6	4.2	4.8	5.4
2CPm 25/14B	2CP 25/14B	1.1	1.5	IE2 IE3	H metres	54	52	50	47.5	44.5	41	37	32.5	27.5	22
2CPm 25/14A	2CP 25/14A	1.5	2			67	65	63	60.5	57.5	54	49.5	44.5	39	32

**2CP 25/16**

TYPE		POWER (P <sub>2</sub> )		1~3~	Q	m <sup>3</sup> /h								
Single-phase	Three-phase	kW	HP			l/min	0	1.2	2.4	3.6	4.8	6	7.2	8.4
2CPm 25/16C	2CP 25/16C	1.1	1.5			47	46	44	40.5	36	30.5	24		
2CPm 25/16B	2CP 25/16B	1.5	2	IE2 IE3	H metres	58	56	54	51	47.5	43	37	30	
2CPm 25/16A	2CP 25/16A	2.2	3			68	67	65	62	58.5	54	48	40.5	32

Q = Flow rate H = Total manometric head HS = Suction height

Performance curves comply with EN ISO 9906 Grade 3B tolerance limits.

## 2CP 32/200

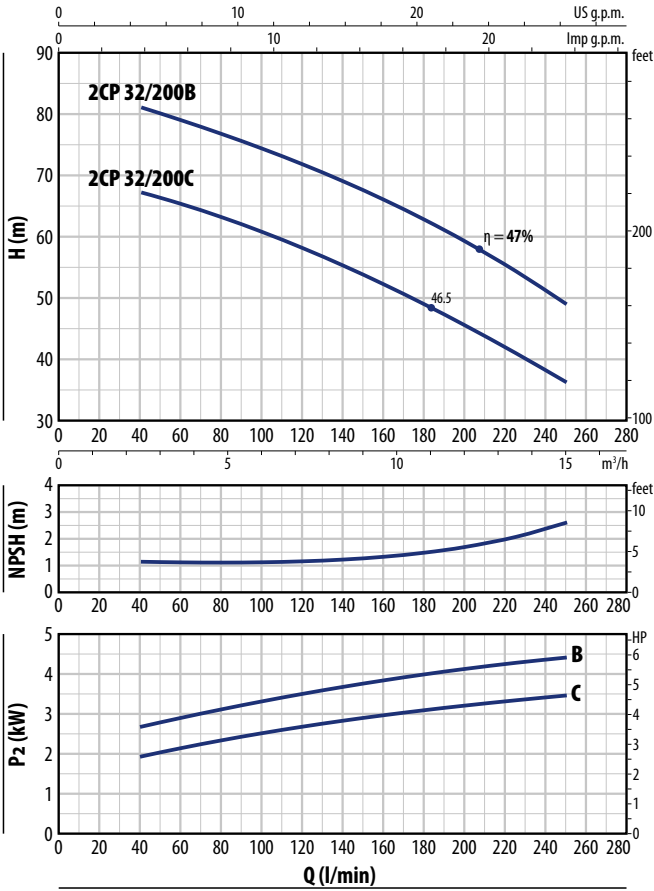

## 2CP 32/210

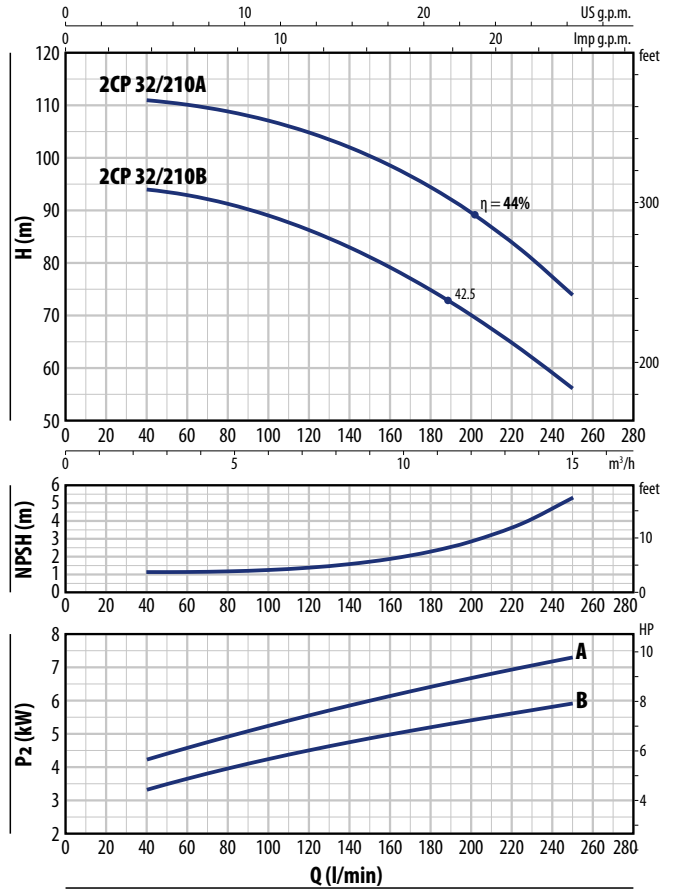

## 2CP 32/200

TYPE	POWER (P <sub>2</sub> )		3~	Q	Q														
	kW	HP			m <sup>3</sup> /h	0	2.4	3.6	4.8	6	7.2	8.4	9.6	10.8	12	13.5	15		
Three-phase					0	40	60	80	100	120	140	160	180	200	225	250			
2CP 32/200C	3	4	IE3	H metres	70	67	65	63	60.5	58	55	52	48.5	45.5	41	36			
2CP 32/200B	4	5.5			85	81	79	77	74.5	71.5	69	66	62.5	59	54.5	49			

## 2CP 32/210

TYPE	POWER (P <sub>2</sub> )		3~	Q	Q														
	kW	HP			m <sup>3</sup> /h	0	2.4	3.6	4.8	6	7.2	8.4	9.6	10.8	12	13.5	15		
Three-phase					0	40	60	80	100	120	140	160	180	200	225	250			
2CP 32/210B	5.5	7.5	IE3	H metres	94	94	93	91	89	86	83	79	75	70	63.5	56			
2CP 32/210A	7.5	10			112	111	110	109	107	105	102	99	95	90	82.5	74			

Q = Flow rate H = Total manometric head HS = Suction height

Performance curves comply with EN ISO 9906 Grade 3B tolerance limits.

### 2CP 40/180

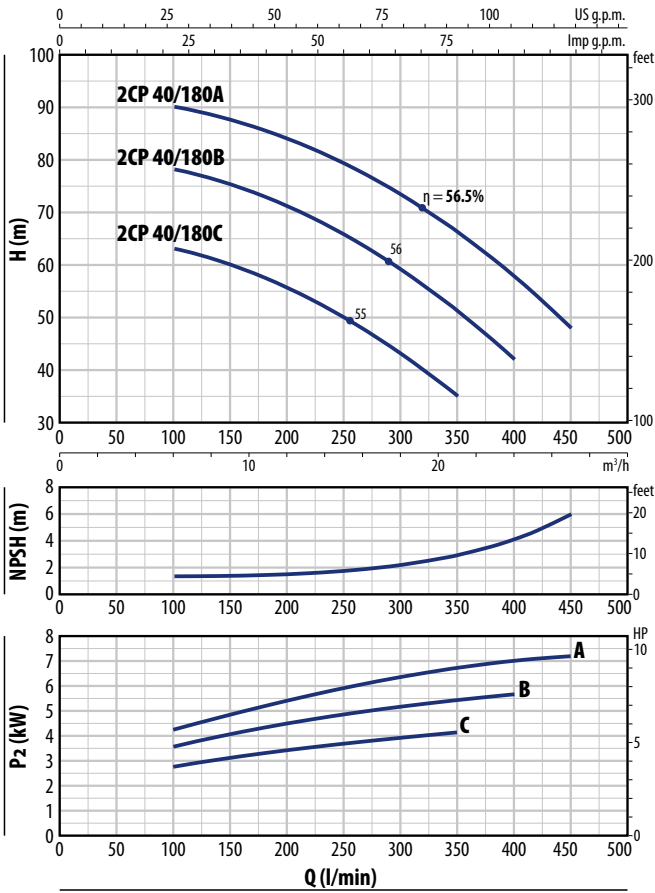

### 2CP 40/200

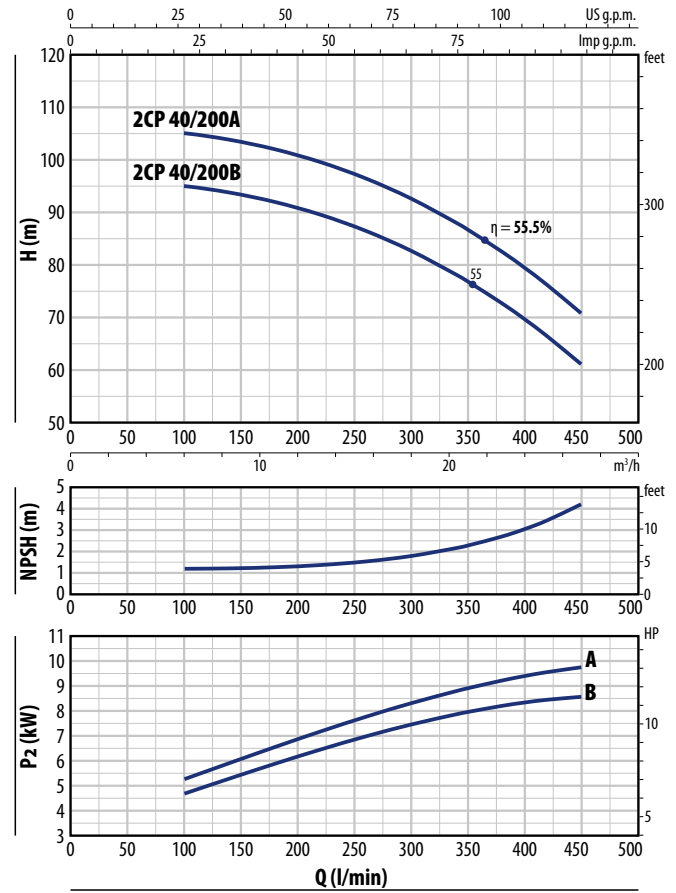

### 2CP 40/180

TYPE	POWER (P <sub>2</sub> )		3~	Q	Q												
	kW	HP			m <sup>3</sup> /h	0	6	9	12	15	18	21	24	27			
Three-phase				l/min	0	100	150	200	250	300	350	400	450				
2CP 40/180C	4	5.5	IE3	H metres	65	63	60	55.5	50	43	35						
2CP 40/180B	5.5	7.5			80	78	75	71	65.5	59	51	42					
2CP 40/180A	7.5	10			92	90	87.5	84	79	73.5	66	58	48				

### 2CP 40/200

TYPE	POWER (P <sub>2</sub> )		3~	Q	Q												
	kW	HP			m <sup>3</sup> /h	0	6	9	12	15	18	21	24	27			
Three-phase				l/min	0	100	150	200	250	300	350	400	450				
2CP 40/200B	9.2	12.5	IE3	H metres	96	95	93	91	87	83	77	69.5	61				
2CP 40/200A	11	15			106	105	103	101	97	93	87	79.5	71				

Q = Flow rate H = Total manometric head HS = Suction height

Performance curves comply with EN ISO 9906 Grade 3B tolerance limits.

### ABSORPTION

TYPE	VOLTAGE
<b>Single-phase</b>	<b>230 V</b>
2CPm 25/14B	7.7 A
2CPm 25/14A	10.5 A
2CPm 25/16C	7.7 A
2CPm 25/16B	10.0 A
2CPm 25/16A	13.8 A

TYPE	VOLTAGE			
	230 V - Δ	400 V - Δ	400 V - Δ	690 V - Δ
<b>Three-phase</b>				
2CP 25/14B	5.4 A	3.1 A	-	-
2CP 25/14A	6.9 A	4.0 A	-	-
2CP 25/16C	5.4 A	3.1 A	-	-
2CP 25/16B	6.9 A	4.0 A	-	-
2CP 25/16A	9.2 A	5.3 A	-	-
2CP 32/200C	12.8 A	7.4 A	-	-
2CP 32/200B	18.2 A	10.5 A	-	-
2CP 32/210B	-	-	12.5 A	7.2 A
2CP 32/210A	-	-	16.0 A	9.2 A
2CP 40/180C	17.0 A	9.8 A	-	-
2CP 40/180B	-	-	12.3 A	7.1 A
2CP 40/180A	-	-	15.4 A	8.9 A
2CP 40/200B	-	-	17.5 A	10.1 A
2CP 40/200A	-	-	20.0 A	11.6 A

### DIMENSIONS AND WEIGHT

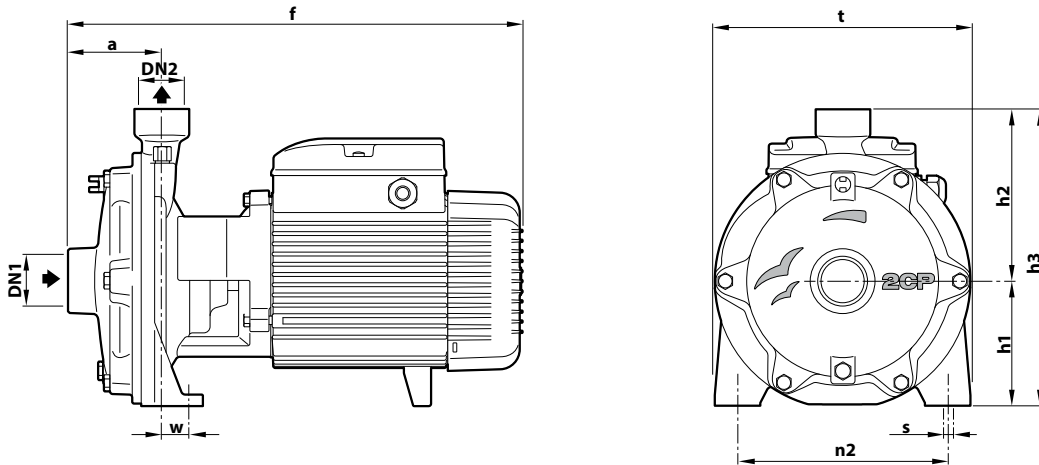

TYPE		PORTS		DIMENSIONS mm									kg	
Single-phase	Three-phase	DN1	DN2	a	f	h1	h2	h3	t	n2	w	s	1~	3~
2CPm 25/14B	2CP 25/14B	1 1/4"	1"	82	404	93	130	223	200	162	17	10	20.8	20.8
2CPm 25/14A	2CP 25/14A					110	151	261	225	185	26	11	24.7	24.6
2CPm 25/16C	2CP 25/16C					93	130	223	200	162	17	10	21.3	20.6
2CPm 25/16B	2CP 25/16B					110	151	261	226	185	26	11	24.5	24.4
2CPm 25/16A	2CP 25/16A			424									27.1	27.3
-	2CP 32/200C	1 1/2"	1 1/4"	95	464	132	172	304	266	206	19	14	-	38.9
-	2CP 32/200B												-	42.0
-	2CP 32/210B												-	54.9
-	2CP 32/210A			541									-	60.0
-	2CP 40/180C	2"	1 1/2"	108	496	139	195	334	292	232	21	14	-	48.7
-	2CP 40/180B												-	53.0
-	2CP 40/180A												-	59.0
-	2CP 40/200B												-	93.0
-	2CP 40/200A			110	620	160	195	355	298				-	92.0

### PALLET CAPACITY

TYPE		NO. OF PUMPS
<b>Single-phase</b>	<b>Three-phase</b>	
2CPm 25/14B	2CP 25/14B	50
2CPm 25/14A	2CP 25/14A	50
2CPm 25/16C	2CP 25/16C	50
2CPm 25/16B	2CP 25/16B	50
2CPm 25/16A	2CP 25/16A	35

TYPE	NO. OF PUMPS
<b>Three-phase</b>	
2CP 32/200C	18
2CP 32/200B	18
2CP 32/210B	12
2CP 32/210A	12
2CP 40/180C	12
2CP 40/180B	12
2CP 40/180A	12
2CP 40/200B	6
2CP 40/200A	6

## MATERIALS AND COMPONENTS

<b>1</b>	<b>Suction body</b>	Cast iron with ISO 228/1 threaded suction port			
<b>2</b>	<b>Delivery port</b>	Cast iron with ISO 228/1 threaded delivery port			
<b>3</b>	<b>Impellers</b>	Brass			
<b>4</b>	<b>Mechanical seal</b>	Water pump	Seal	Shaft	Materials
		2CP 25/14	<b>FN-18</b>	Ø 18 mm	Graphite / Ceramic / NBR
		2CP 25/16	<b>FN-18</b>	Ø 18 mm	Graphite / Ceramic / NBR
		2CP 32/200	<b>FN-20</b>	Ø 20 mm	Graphite / Ceramic / NBR
		2CP 32/210	<b>FN-24</b>	Ø 24 mm	Graphite / Ceramic / NBR
		2CP 40/180	<b>FN-24</b>	Ø 24 mm	Graphite / Ceramic / NBR
		2CP 40/200	<b>FN-32 NU</b>	Ø 32 mm	Graphite / Ceramic / NBR
<b>5</b>	<b>Motor shaft</b>	Stainless steel <b>AISI 431</b>			
<b>6</b>	<b>Electric motor</b>	<p><b>2CPm</b>: single-phase 230 V - 50Hz with winding integrated thermal motor protection</p> <p><b>2CP</b>: three-phase 230/400 V - 50 Hz up to 4 kW 400/690 V - 50 Hz 5.5 to 11 kW</p> <p>※ Pumps are equipped with high-efficiency motors (IEC 60034-30-1)</p> <p>class <b>IE2</b> for single-phase models</p> <p>class <b>IE3</b> for three-phase models</p> <p>Continuous running duty <b>S1</b></p>			

