

PERFORMANCE RANGE

- Flow rate up to **5750 l/min** (345 m³/h)
- Head up to **98 m**
- Power from **1.5 to 75 kW**

INSTALLATION AND USE

Close-coupled centrifugal electric pumps with flanges constructed according to the EN733 standard.

- For clean water free from abrasive particles and liquids that will not damage the pump's components
- Water supply
- Pressurization
- Irrigation
- Water circulation in air conditioning systems
- Power washing systems
- Firefighting systems
- Industrial applications
- Agriculture applications

Installation should be carried out in well-ventilated indoor or protected areas.

ELECTRIC MOTOR

The three-phase pumps are equipped with newly developed electric motors designed to work with inverters, which guarantee stable and quiet operation.

Efficiency class **IE3** for three-phase motors, **IE2** for single-phase motors, class F insulation and IP55 protection.

APPLICATION LIMITS

- Manometric suction head up to **7 m**
- Liquid temperature between **-10 °C** and **+90 °C**
- Ambient temperature between **-10 °C** and **+40 °C**
- Maximum pressure in the pump body **10 bar** (PN10)

AVAILABLE UPON REQUEST

- ✘ Mechanical seal options available
- ✘ Different voltage requirements 60 Hz frequency
- ✘ Handling of liquids with higher or lower temperatures
- ✘ Adaptability to operate in high or low temperature environments
- ✘ Counterflange KIT including screws, nuts and gaskets



PERFORMANCE RANGE - n= 2900 min⁻¹

50 Hz

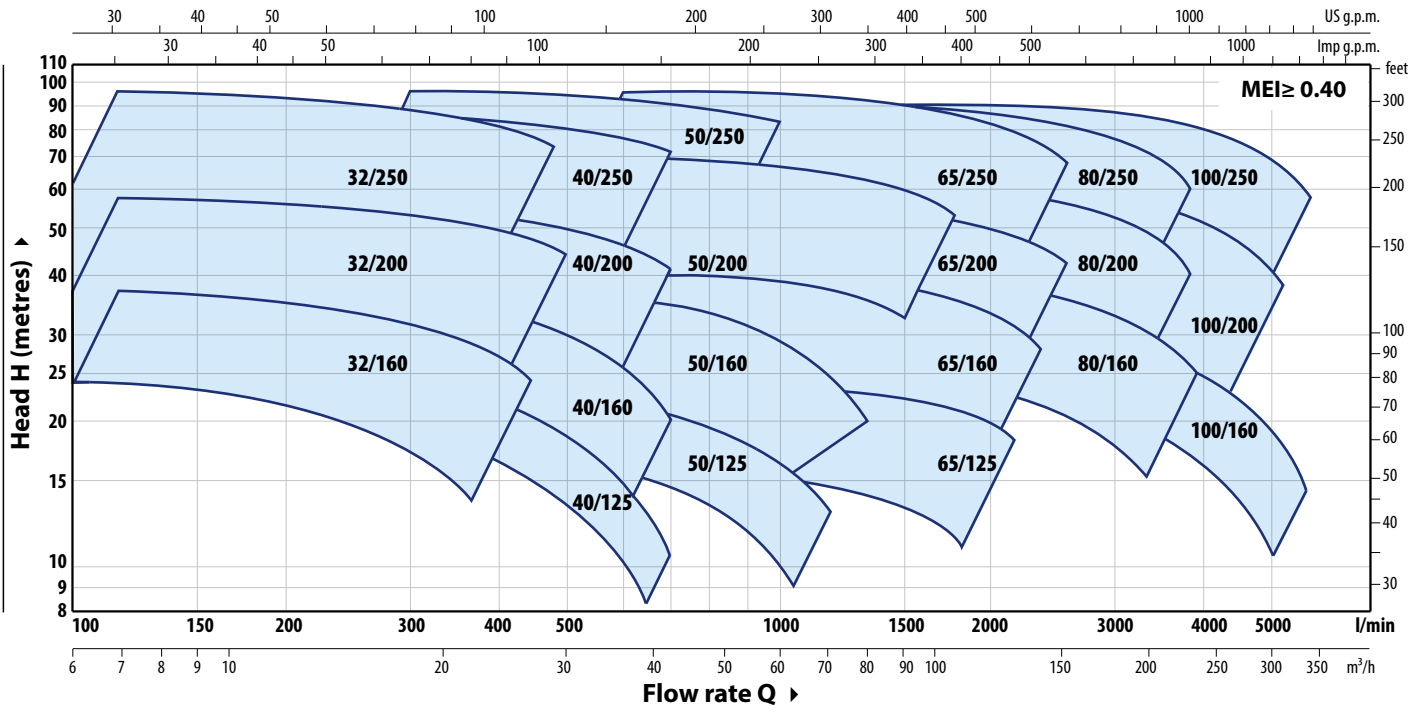

PERFORMANCE DATA - n= 2900 min⁻¹

50 Hz

TYPE	POWER (P ₂)		PERFORMANCE	
	kW	HP	Q l/min	H metres
F 32/160C	1.5	2	100 – 350	24 – 14
F 32/160B	2.2	3	100 – 400	30 – 17
F 32/160A	3	4	100 – 450	37 – 24
F 32/200C	4	5.5	100 – 450	44 – 31.5
F 32/200B	5.5	7.5	100 – 500	51 – 36
F 32/200A	7.5	10	100 – 500	57 – 44
F 32/200BH	3	4	100 – 300	45 – 37
F 32/200AH	4	5.5	100 – 320	55 – 44
F 32/250C	9.2	12.5	100 – 450	75 – 60
F 32/250B	11	15	100 – 500	87 – 70
F 32/250A	15	20	100 – 500	97 – 80
F 40/125C	1.1	1.5	100 – 550	16 – 6
F 40/125B	1.5	2	100 – 600	20.5 – 9
F 40/125A	2.2	3	100 – 700	26 – 10
F 40/160C	2.2	3	100 – 600	27 – 14
F 40/160B	3	4	100 – 600	32 – 20
F 40/160A	4	5.5	100 – 700	38 – 20
F 40/200B	5.5	7.5	100 – 700	47 – 28
F 40/200A	7.5	10	100 – 700	55 – 41
F 40/250C	9.2	12.5	100 – 700	64 – 47
F 40/250B	11	15	100 – 700	71 – 55
F 40/250A	15	20	100 – 700	88 – 72
F 50/125C	2.2	3	300 – 1200	17.5 – 6
F 50/125B	3	4	300 – 1200	20.7 – 9
F 50/125A	4	5.5	300 – 1200	23.5 – 13
F 50/160C	4	5.5	300 – 1000	27 – 16
F 50/160B	5.5	7.5	300 – 1200	32 – 18
F 50/160A	7.5	10	300 – 1350	37.5 – 20
F 50/200C	11	15	400 – 1700	44 – 30
F 50/200B	15	20	400 – 1700	52 – 38
F 50/200A	18.5	25	400 – 1800	61 – 45
F 50/200AR	22	30	400 – 1800	69 – 53

TYPE	POWER (P ₂)		PERFORMANCE	
	kW	HP	Q l/min	H metres
F 50/250D	9.2	12.5	300 – 900	51 – 32
F 50/250C	11	15	300 – 1000	59 – 43
F 50/250B	15	20	300 – 1000	72 – 59
F 50/250A	18.5	25	300 – 1000	85 – 73
F 50/250AR	22	30	300 – 1000	95 – 83
F 65/125C	4	5.5	600 – 1800	16 – 11
F 65/125B	5.5	7.5	600 – 2000	18 – 13
F 65/125A	7.5	10	600 – 2200	23 – 18
F 65/160C	9.2	12.5	600 – 2200	32 – 22
F 65/160B	11	15	600 – 2400	36.5 – 23
F 65/160A	15	20	600 – 2400	40.5 – 28
F 65/200B	15	20	200 – 2400	44 – 30.5
F 65/200A	18.5	25	200 – 2500	50 – 36.5
F 65/200AR	22	30	200 – 2600	57 – 42
F 65/250C	30	40	400 – 2350	76 – 53
F 65/250B	37	50	400 – 2500	87 – 62
F 65/250A	45	60	400 – 2600	95 – 68
F 80/160D	11	15	500 – 4000	25 – 10
F 80/160C	15	20	500 – 4000	30 – 15
F 80/160B	18.5	25	500 – 4000	35 – 20
F 80/160A	22	30	500 – 4000	40 – 25
F 80/200B	30	40	500 – 3650	56 – 34.5
F 80/200A	37	50	500 – 3900	62 – 40
F 80/250B	45	60	600 – 3600	77 – 54
F 80/250A	55	75	600 – 3900	88.5 – 60
F 100/160C	15	20	1000 – 5000	30 – 12
F 100/160B	18.5	25	1000 – 5200	34 – 14.5
F 100/160A	22	30	1000 – 5500	38 – 17.5
F 100/200C	30	40	833 – 4650	51 – 28
F 100/200B	37	50	833 – 4900	57 – 33
F 100/200A	45	60	833 – 5250	63 – 38
F 100/250B	55	75	800 – 5150	75 – 48
F 100/250A	75	100	800 – 5750	89 – 58

F 32

CURVES AND PERFORMANCE DATA – HS=0 m

50 Hz

F 32/160

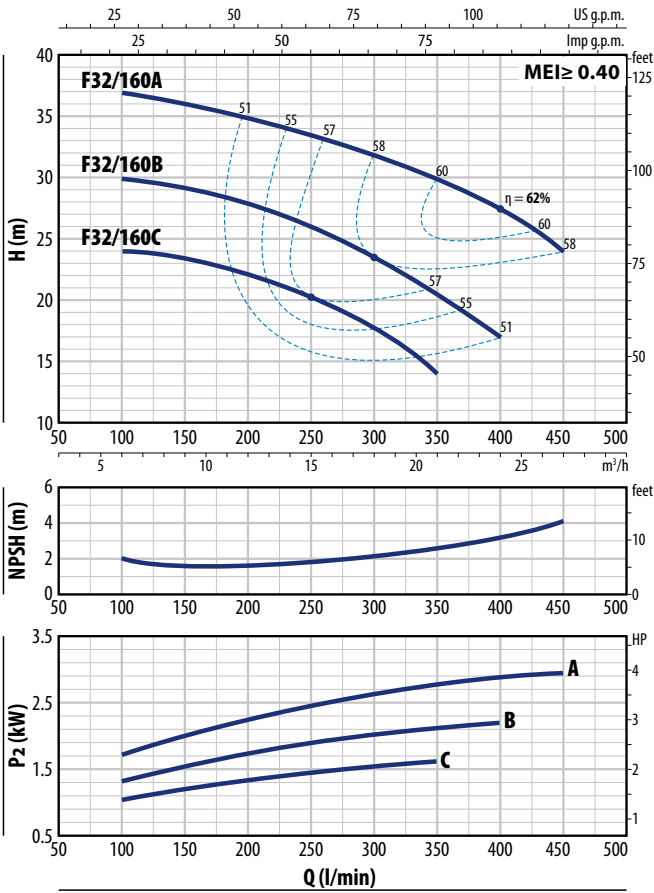

F 32/200

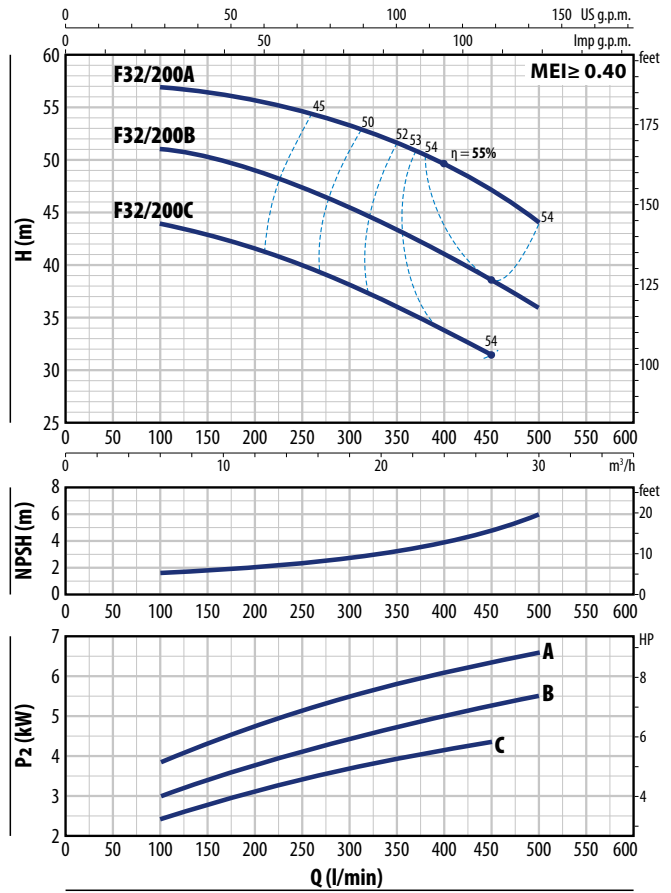

F 32/160

TYPE		POWER (P ₂)		1~3~	Q	m ³ /h												
Single-ph.	Three-ph.	kW	HP			l/min	0	6	9	12	15	18	21	24	27			
Fm 32/160C	F 32/160C	1.5	2	IE2 IE3	H metres	0	100	150	200	250	300	350	400	450				
Fm 32/160B	F 32/160B	2.2	3			25	24	23.5	22	20.5	18	14						
-	F 32/160A	3	4			31	30	29	28	26	23.5	20.5	17					
						38	37	36	35	33.5	31.5	30	27.5	24				

F 32/200

TYPE		POWER (P ₂)		3~	Q	m ³ /h												
Three-ph.		kW	HP			l/min	0	6	9	12	15	18	21	24	27	30		
F 32/200C		4	5.5	IE3	H metres	0	100	150	200	250	300	350	400	450	500			
F 32/200B		5.5	7.5			46	44	43	41.5	40	38	36	34	31.5				
F 32/200A		7.5	10			52	51	50.5	49	47	45	43	41	38.5	36			
						60	57	56.5	56	55	53.5	52	50	47	44			

Q = Flow rate H = Total manometric head HS = Suction height

Performance curves comply with EN ISO 9906 Grade 3B tolerance limits.

CURVES AND PERFORMANCE DATA – HS=0 m

50 Hz

F 32/200H

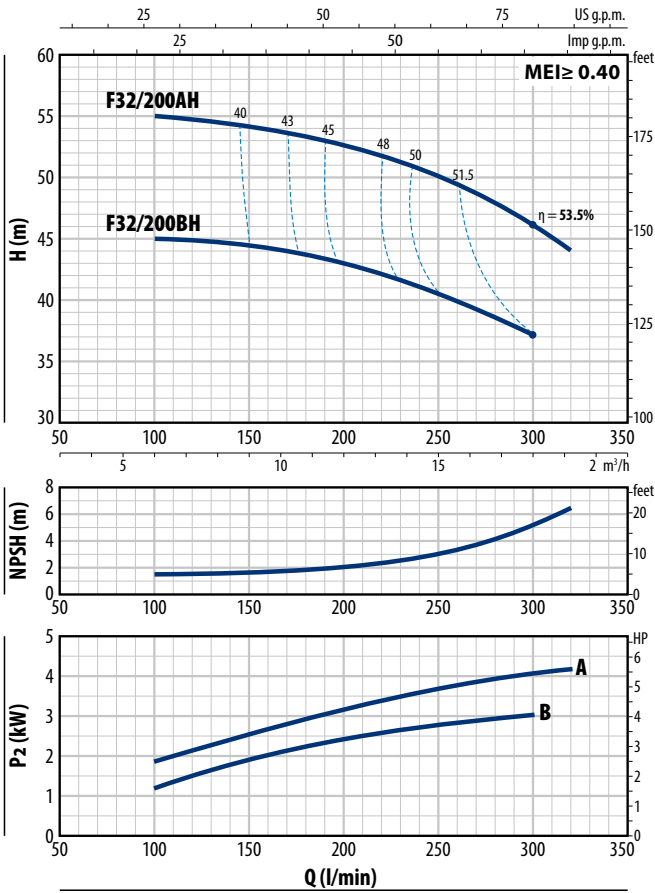

F 32/250

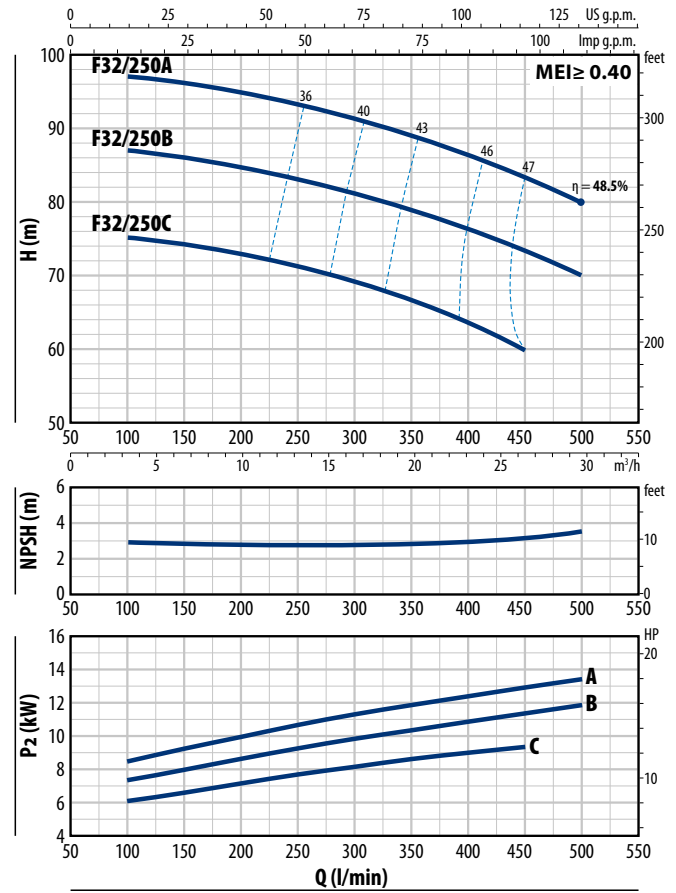

F 32/200H

TYPE	POWER (P ₂)		3~	Q	Q							
	kW	HP			m ³ /h	0	6	9	12	15	18	19.2
Three-phase				l/min	0	100	150	200	250	300	320	
F 32/200BH	3	4	IE3	H metres	47	45	44.5	43	40.5	37		
F 32/200AH	4	5.5			57	55	54	52.5	50	46	44	

F 32/250

TYPE	POWER (P ₂)		3~	Q	Q									
	kW	HP			m ³ /h	0	6	9	12	15	18	21	24	27
Three-phase				l/min	0	100	150	200	250	300	350	400	450	500
F 32/250C	9.2	12.5	IE3	H metres	76	75	74.5	73	71.5	69.5	67	64	60	
F 32/250B	11	15			88	87	86	85	83	81	79	76.5	73.5	70
F 32/250A	15	20			98	97	96	95	93	91	89	86.5	83.5	80

Q = Flow rate H = Total manometric head HS = Suction height

Performance curves comply with EN ISO 9906 Grade 3B tolerance limits.

F 40

CURVES AND PERFORMANCE DATA – HS=0 m

50 Hz

F 40/125

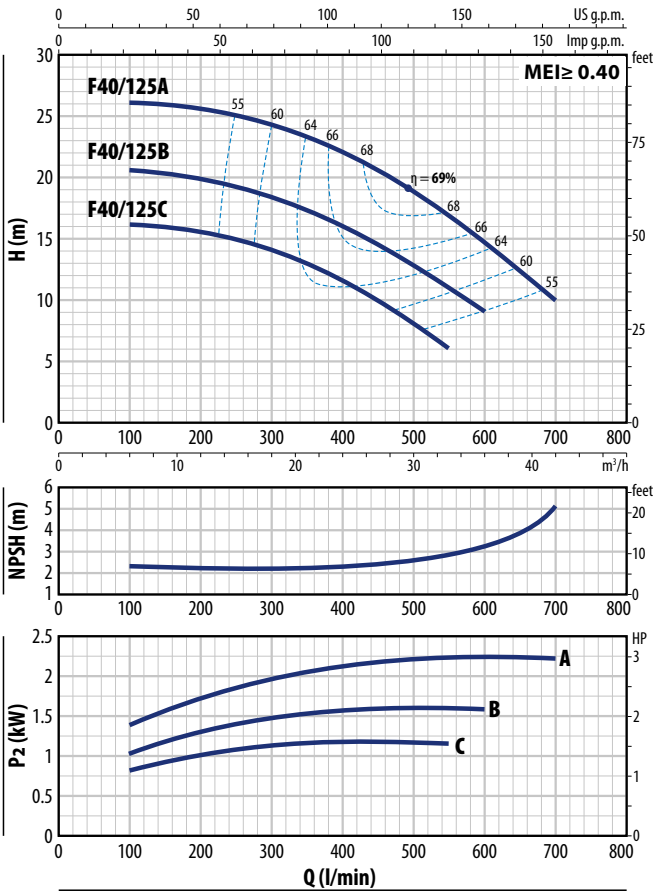

F 40/160

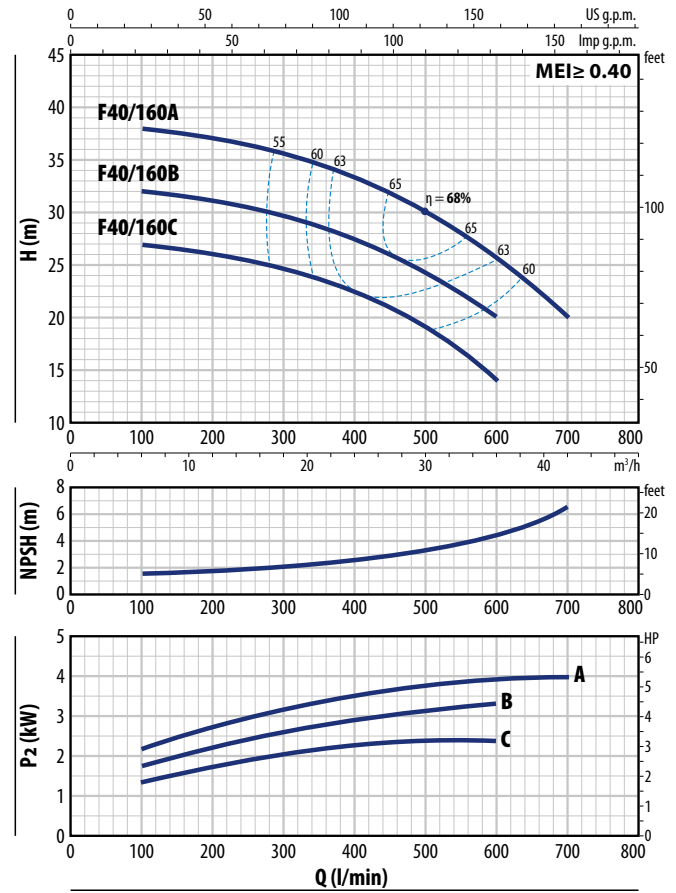

F 40/125

TYPE		POWER (P ₂)		1~3~	Q	m ³ /h									
Single-phase	Three-phase	kW	HP			0	6	12	18	24	30	33	36	39	42
Fm 40/125C	F 40/125C	1.1	1.5		0	100	200	300	400	500	550	600	650	700	
Fm 40/125B	F 40/125B	1.5	2	IE2 IE3	H metres	20.5	20.5	19.8	18.5	16	12.8	11	9		
-	F 40/125A	2.2	3			26	26	25.5	24	22	18.5	17	14.5	12.5	10

F 40/160

TYPE		POWER (P ₂)		1~3~	Q	m ³ /h									
Single-phase	Three-phase	kW	HP			0	6	9	12	15	18	24	30	36	42
Fm 40/160C	F 40/160C	2.2	3		0	100	150	200	250	300	400	500	600	700	
-	F 40/160B	3	4	IE2 IE3	H metres	32	32	31.5	31	30.5	30	27.5	24	20	
-	F 40/160A	4	5.5			38	38	37.8	37	36.5	36	33.5	30	26	20

Q = Flow rate H = Total manometric head HS = Suction height

Performance curves comply with EN ISO 9906 Grade 3B tolerance limits.

CURVES AND PERFORMANCE DATA – HS=0 m

50 Hz

F 40/200

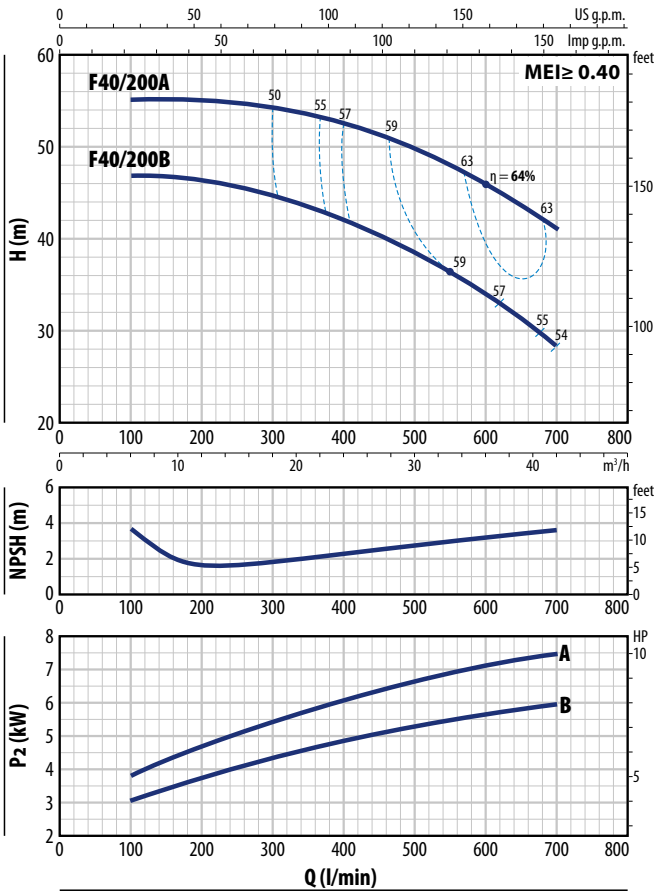

F 40/250

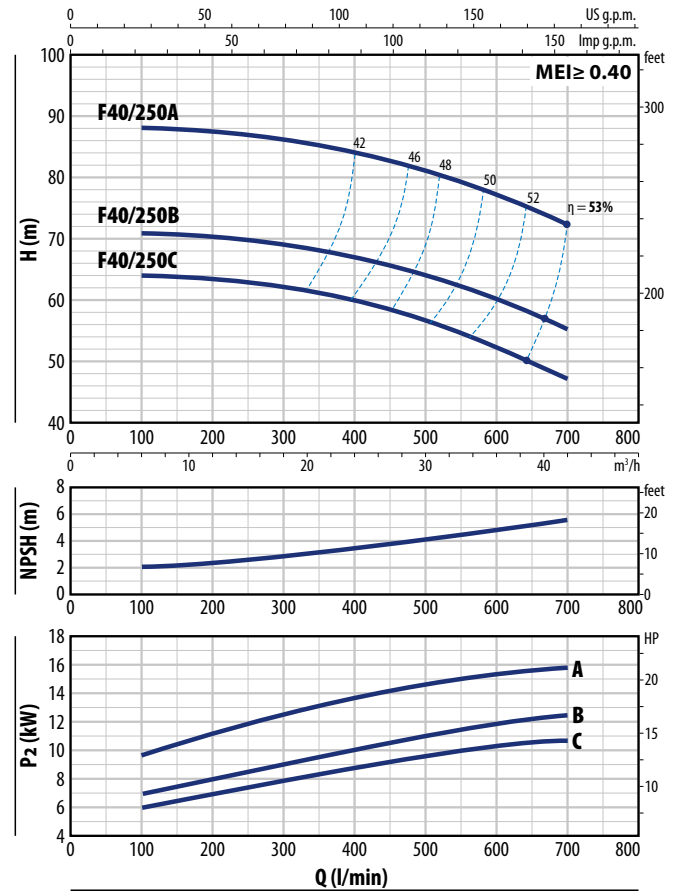

F 40/200

TYPE	POWER (P ₂)		3~	Q	m ³ /h													
	kW	HP			0	6	9	12	15	18	24	30	36	42				
Three-phase				l/min	0	100	150	200	250	300	400	500	600	700				
F 40/200B	5.5	7.5	IE3	H metres	48	47	46.5	46	45.5	44.5	42	38	34	28				
F 40/200A	7.5	10			56	55	55	55	54.5	54	52.5	49.5	46	41				

F 40/250

TYPE	POWER (P ₂)		3~	Q	m ³ /h													
	kW	HP			0	6	9	12	15	18	24	30	36	42				
Three-phase				l/min	0	100	150	200	250	300	400	500	600	700				
F 40/250C	9.2	12.5	IE3	H metres	64	64	63.5	63	62.5	62	60	56.5	52.5	47				
F 40/250B	11	15			71	71	70.5	70	69.5	69	67	64	60	55				
F 40/250A	15	20			88	88	87.5	87	86.5	86	84	81	77	72				

Q = Flow rate H = Total manometric head HS = Suction height

Performance curves comply with EN ISO 9906 Grade 3B tolerance limits.

F 50

CURVES AND PERFORMANCE DATA – HS=0 m

50 Hz

F 50/125

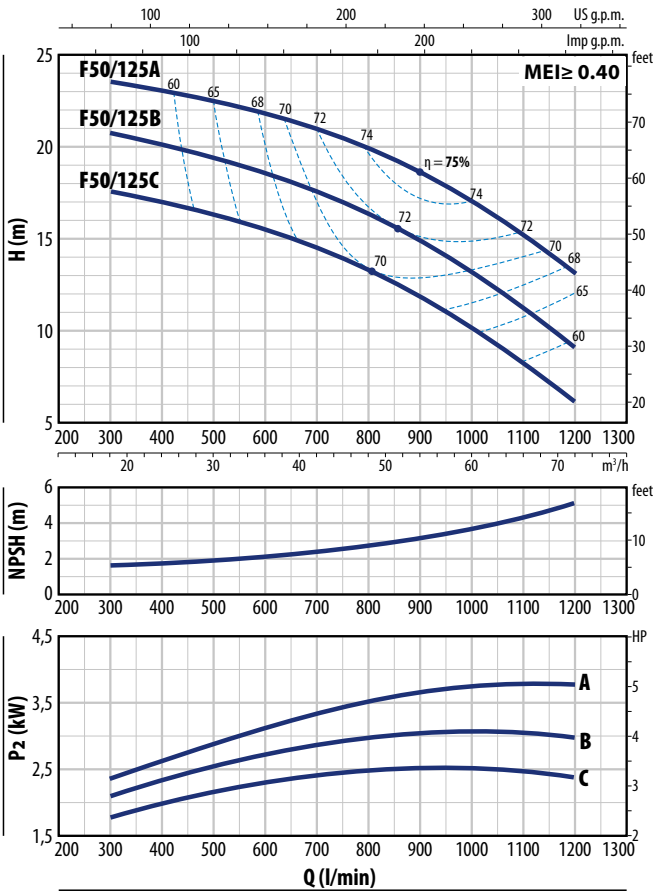

F 50/160

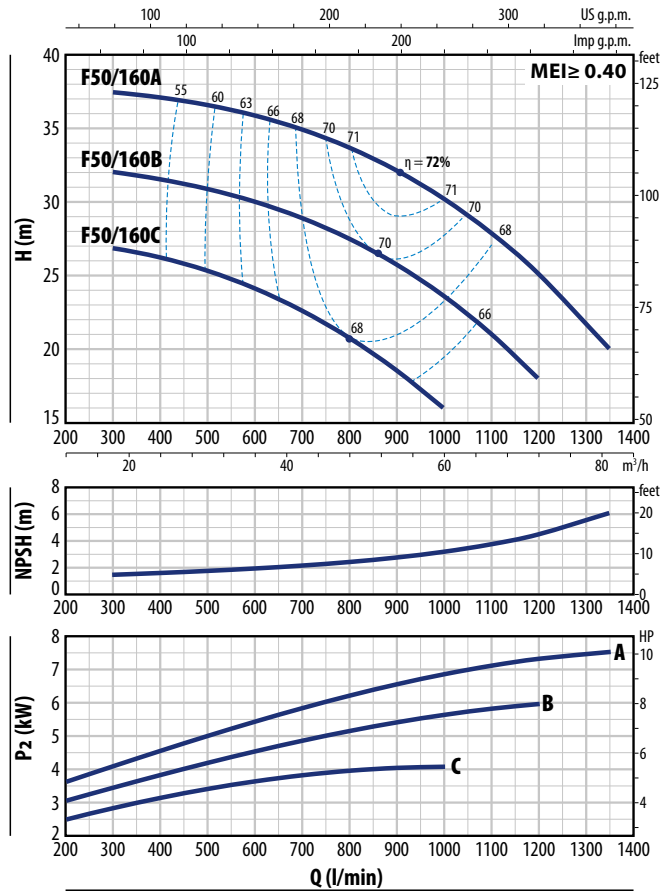

F 50/125

TYPE		POWER (P ₂)		1~3~	Q	m ³ /h												
Single-ph.	Three-ph.	kW	HP			0	18	24	30	36	42	48	54	60	66	72		
Fm 50/125C	F 50/125C	2.2	3	IE2 IE3	H metres	0	300	400	500	600	700	800	900	1000	1100	1200		
-	F 50/125B	3	4			18.5	17.5	17	16.5	15.5	14.8	13.5	12	10.5	8.2	6		
-	F 50/125A	4	5.5			21.5	20.7	20	19.5	18.8	17.8	16.5	15	13.5	11.2	9		
						24.5	23.5	23	22.5	21.8	20.8	19.5	18.3	16.8	15	13		

F 50/160

TYPE		POWER (P ₂)		3~	Q	m ³ /h												
Three-phase		kW	HP			0	18	24	30	36	42	48	54	60	66	72	81	
F 50/160C		4	5.5	IE3	H metres	0	300	400	500	600	700	800	900	1000	1100	1200	1350	
F 50/160B		5.5	7.5			27	27	26.5	25	24.5	23	20	18.5	16				
F 50/160A		7.5	10			33	32	31.7	31	30	29	27.4	25.7	23.5	21	18		
						38	37.5	37	36.5	36	35	33.7	32	30.2	28	25	20	

Q = Flow rate H = Total manometric head HS = Suction height

Performance curves comply with EN ISO 9906 Grade 3B tolerance limits.

CURVES AND PERFORMANCE DATA – HS=0 m

50 Hz

F 50/200

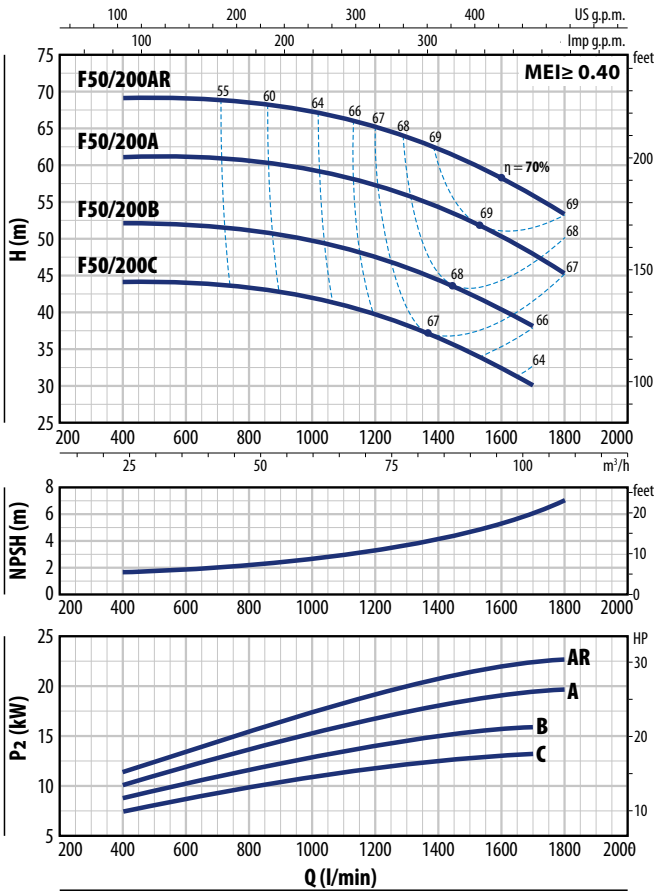

F 50/250

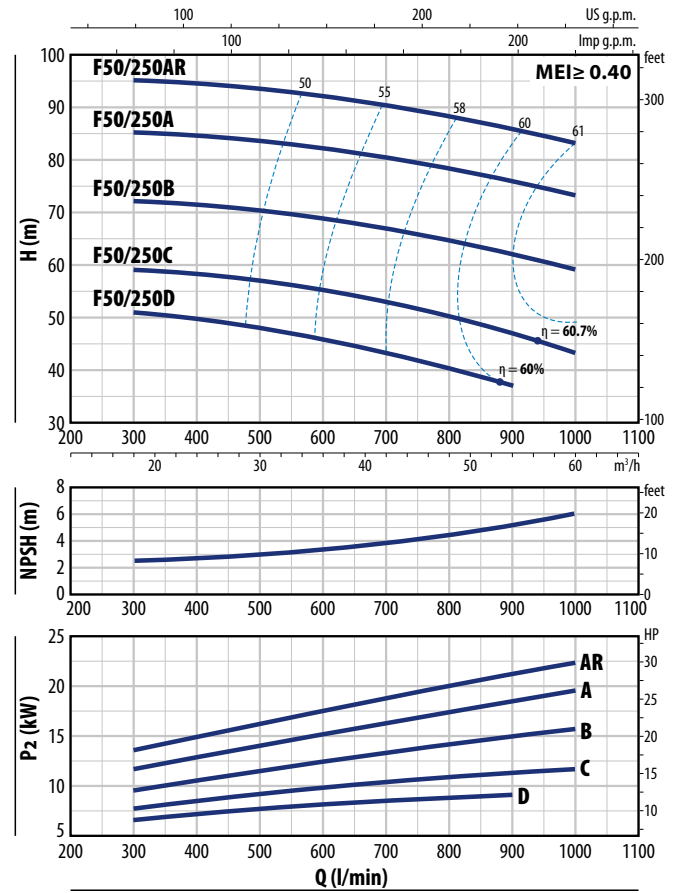

F 50/200

TYPE	POWER (P ₂)		3~	Q	m ³ /h																		
	kW	HP			0	18	24	30	36	42	48	54	60	66	72	78	84	90	96	102	108		
Three-phase					400	600	800	1000	1200	1400	1600	1700	1800										
F 50/200C	11	15	IE3	H metres	44	44	44	42	39	36	33	30											
F 50/200B	15	20			52	52	52	50	47	44	40	38											
F 50/200A	18.5	25			61	61	60.5	60	57	54	50	48	45										
F 50/200AR	22	30			69	69	68.5	68	65	62	58	56	53										

F 50/250

TYPE	POWER (P ₂)		3~	Q	m ³ /h																		
	kW	HP			0	18	24	30	36	42	48	54	60	66	72	78	84	90	96	102	108		
Three-phase					0	300	400	500	600	700	800	900	1000										
F 50/250D	9.2	12.5	IE3	H metres	51	50.5	49.5	48	45.5	43	40	37											
F 50/250C	11	15			59	59	58	56.5	55	53	50	47	43										
F 50/250B	15	20			72	72	71	70	69	67	65	62	59										
F 50/250A	18.5	25			85	85	84	83	82	80	78	76	73										
F 50/250AR	22	30			95	95	94	93	92	90	88	86	83										

Q = Flow rate H = Total manometric head HS = Suction height

Performance curves comply with EN ISO 9906 Grade 3B tolerance limits.

F 65

CURVES AND PERFORMANCE DATA – HS=0 m

50 Hz

F 65/125

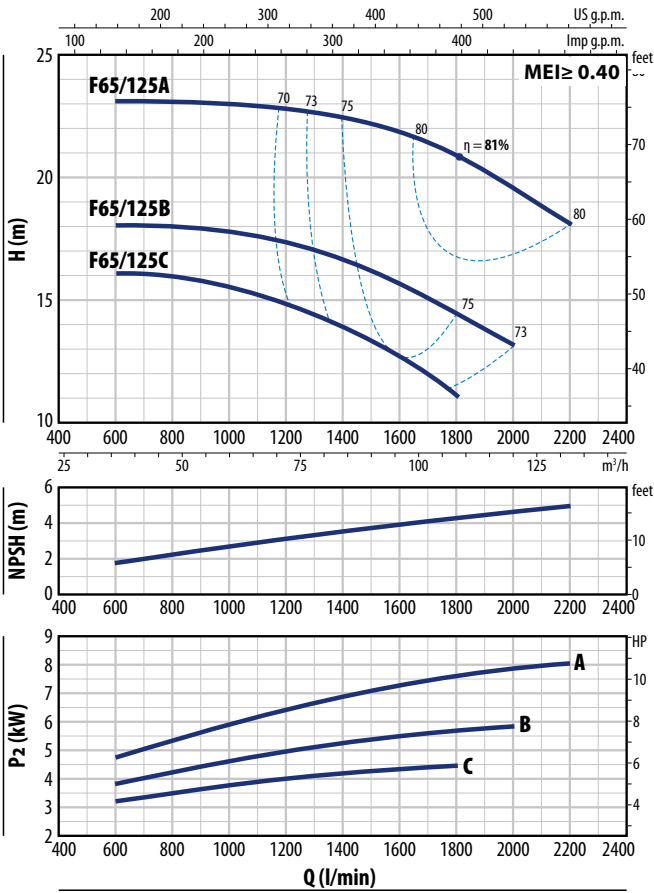

F 65/160

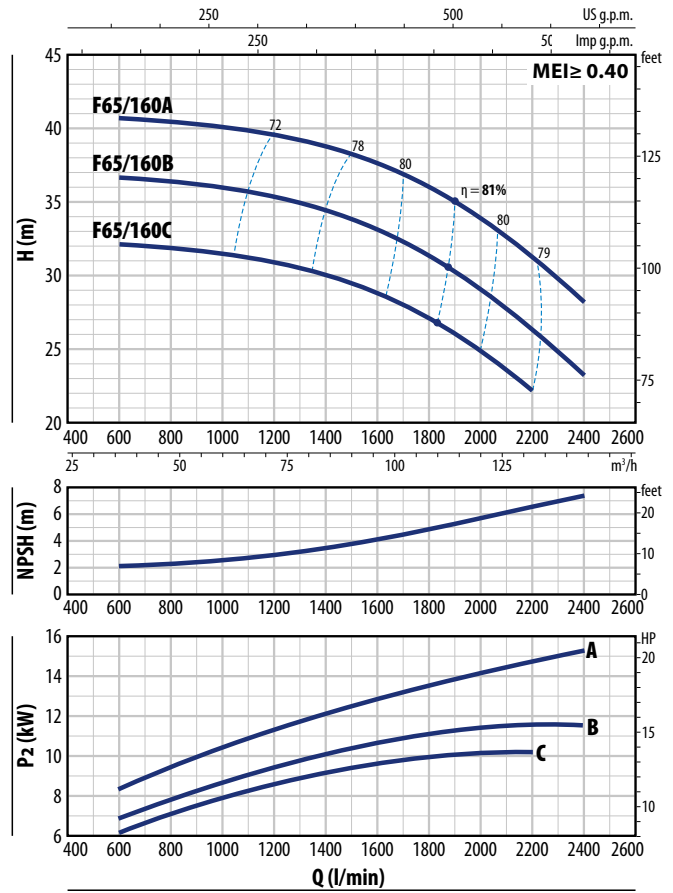

F 65/125

TYPE	POWER (P ₂)		3~	Q	m ³ /h												
	kW	HP			0	36	48	60	72	84	96	108	120	132			
Three-phase				l/min	0	600	800	1000	1200	1400	1600	1800	2000	2200			
F 65/125C	4	5.5	IE3	H metres	16	16	16	15.5	14.5	13.5	12.5	11					
F 65/125B	5.5	7.5			18	18	18	18	17	16.5	15.5	14.5	13				
F 65/125A	7.5	10			23	23	23	23	22.5	22.5	22	21	19.5	18			

F 65/160

TYPE	POWER (P ₂)		3~	Q	m ³ /h													
	kW	HP			0	36	48	60	72	84	96	108	120	132	144			
Three-phase				l/min	0	600	800	1000	1200	1400	1600	1800	2000	2200	2400			
F 65/160C	9.2	12.5	IE3	H metres	32	32	32	32	32	30	29	27	25	22				
F 65/160B	11	15			37	36.5	36.5	36	35.5	34	33	31	29	26	23			
F 65/160A	15	20			41	40.5	40.5	40	39.5	39	37.5	36	34	31	28			

Q = Flow rate H = Total manometric head HS = Suction height

Performance curves comply with EN ISO 9906 Grade 3B tolerance limits.

CURVES AND PERFORMANCE DATA – HS=0 m

50 Hz

F 65/200

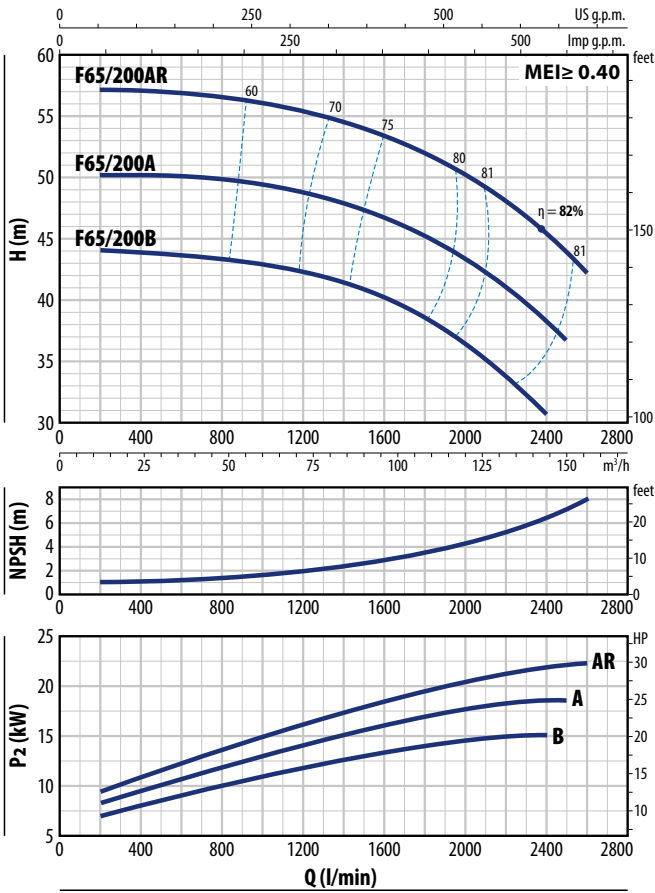

F 65/250

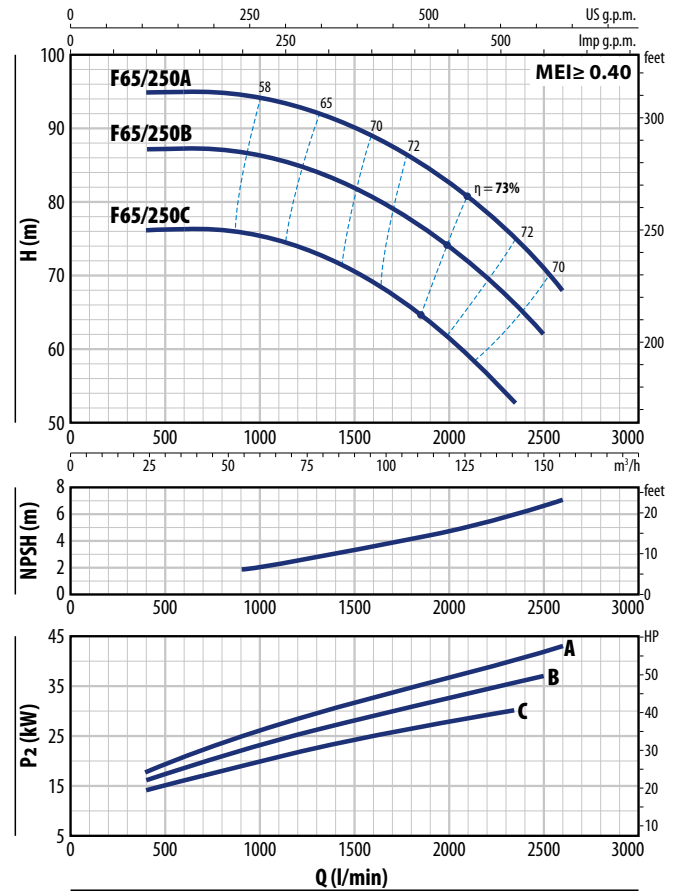

F 65/200

TYPE	POWER (P ₂)		3~	Q	m ³ /h														
	kW	HP			12	36	48	60	72	84	96	108	120	132	144	150	156		
F 65/200B	15	20	IE3	H metres	200	600	800	1000	1200	1400	1600	1800	2000	2200	2400	2500	2600		
F 65/200A	18.5	25			44	43.5	43.3	43	42.5	41.5	40	38.5	36.5	34	30.5				
F 65/200AR	22	30			50	50	50	49.5	49	48	46.5	45	43	41	38	36.5			
					57	57	57	56	55.5	54.5	53.5	52	50	48	45.5	43.5	42		

F 65/250

TYPE	POWER (P ₂)		3~	Q	m ³ /h										
	kW	HP			24	40	60	80	100	120	141	150	156		
F 65/250C	30	40	IE3	H metres	400	667	1000	1333	1667	2000	2350	2500	2600		
F 65/250B	37	50			76	76	75.5	72.5	68	61.5	53				
F 65/250A	45	60			87	87	86	84	80	74	66.5	62			
					95	95	94	92	88	82.5	75	71	68		

Q = Flow rate H = Total manometric head HS = Suction height

Performance curves comply with EN ISO 9906 Grade 3B tolerance limits.

F 80

CURVES AND PERFORMANCE DATA – HS=0 m

50 Hz

F 80/160

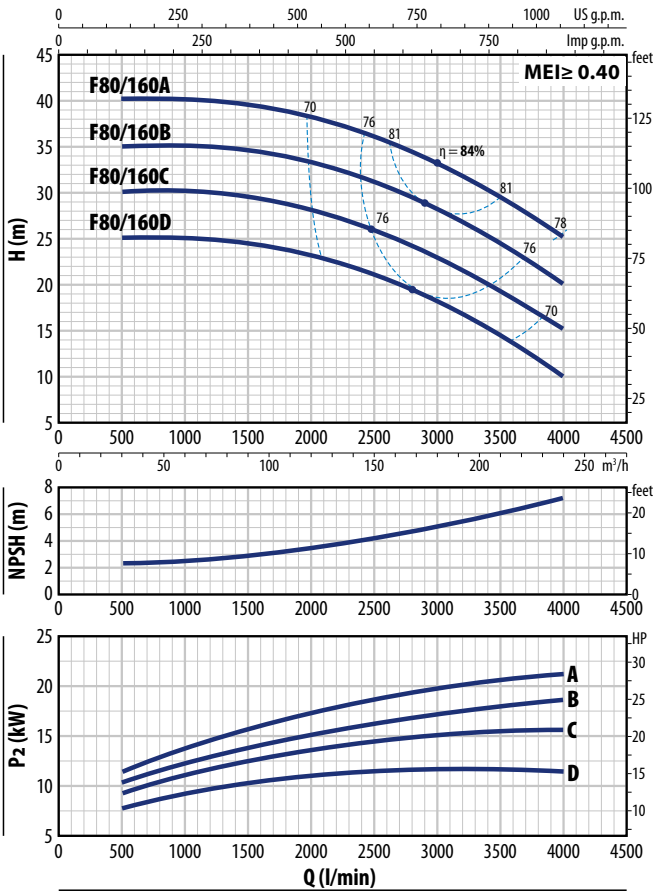

F 80/200

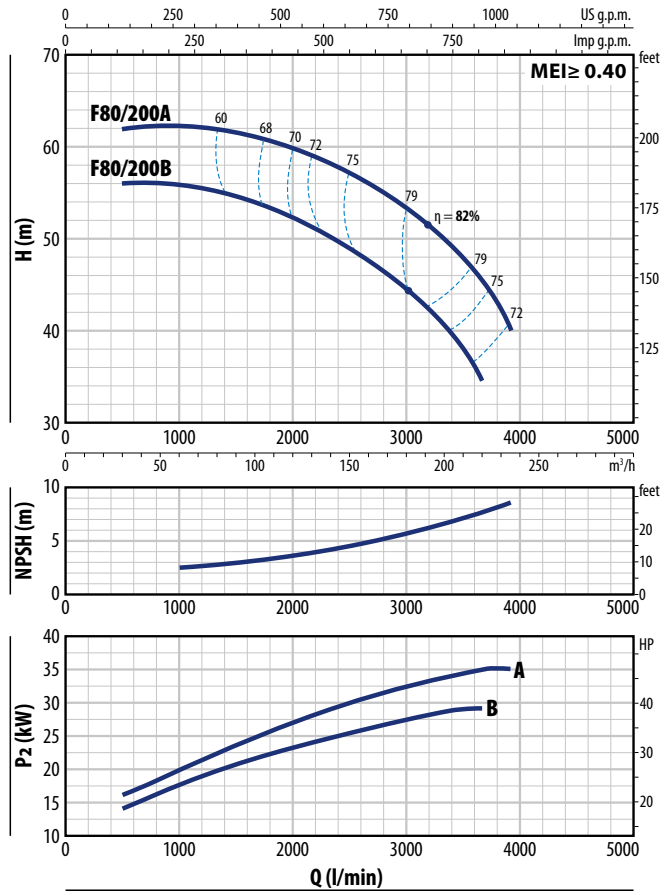

F 80/160

TYPE	POWER (P ₂)		3~	Q	m ³ /h											
	kW	HP			0	30	60	90	120	150	180	210	240			
Three-phase					0	500	1000	1500	2000	2500	3000	3500	4000			
F 80/160D	11	15	IE3	H metres	25	25	25	24.5	23.5	21	18	14.5	10			
F 80/160C	15	20			30	30	30	29.5	28.5	26	23	19.5	15			
F 80/160B	18.5	25			35	35	35	34.5	33.5	31	28.5	24.5	20			
F 80/160A	22	30			40	40	40	39.5	38.5	36	33	29.5	25			

F 80/200

TYPE	POWER (P ₂)		3~	Q	m ³ /h						
	kW	HP			30	50	100	150	200	219	234
Three-phase					500	833	1667	2500	3333	3650	3900
F 80/200B	30	40	IE3	H metres	56	56	54	49	41	34.5	
F 80/200A	37	50			62	62	61	57	50	45.5	40

Q = Flow rate H = Total manometric head HS = Suction height

Performance curves comply with EN ISO 9906 Grade 3B tolerance limits.

F 80/250

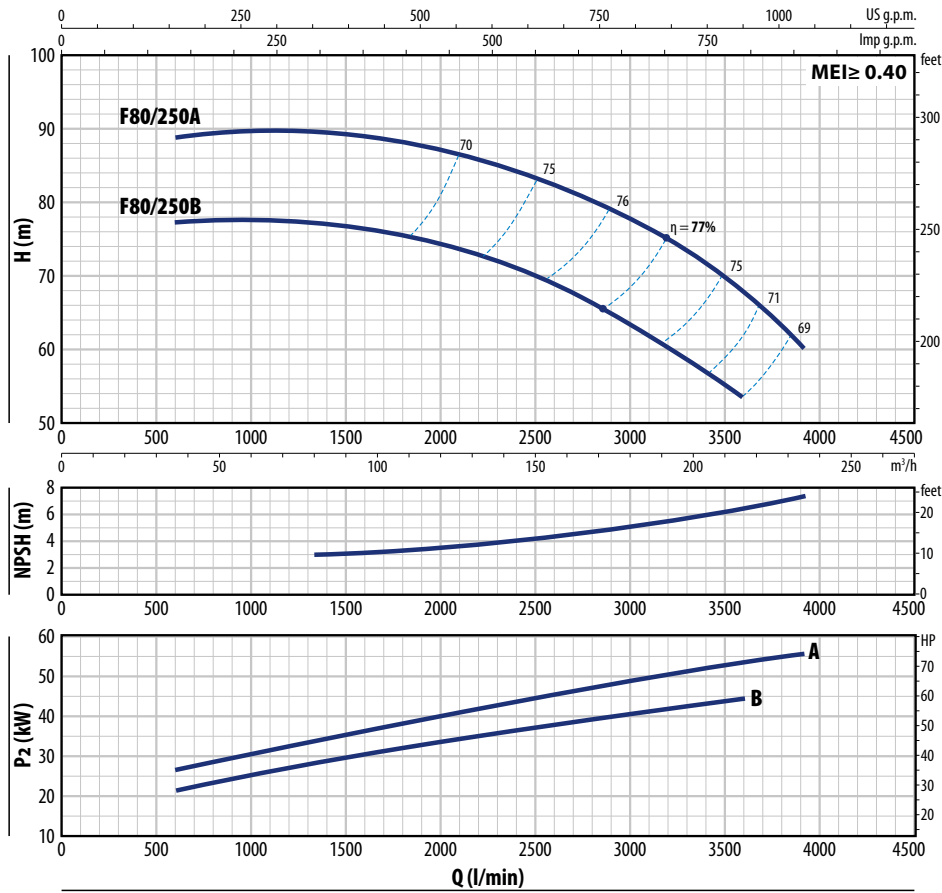

F 80/250

TYPE	POWER (P ₂)		3~	Q	Q						
	kW	HP			m ³ /h	36	50	100	150	200	216
Three-phase				l/min	600	833	1667	2500	3333	3600	3900
F 80/250B	45	60	IE3	H metres	77	77.5	76	70.5	58.5	54	
F 80/250A	55	75			88.5	89.5	89	83	72	68	60

Q = Flow rate H = Total manometric head HS = Suction height

Performance curves comply with EN ISO 9906 Grade 3B tolerance limits.

F 100

CURVES AND PERFORMANCE DATA – HS=0 m

50 Hz

F 100/160

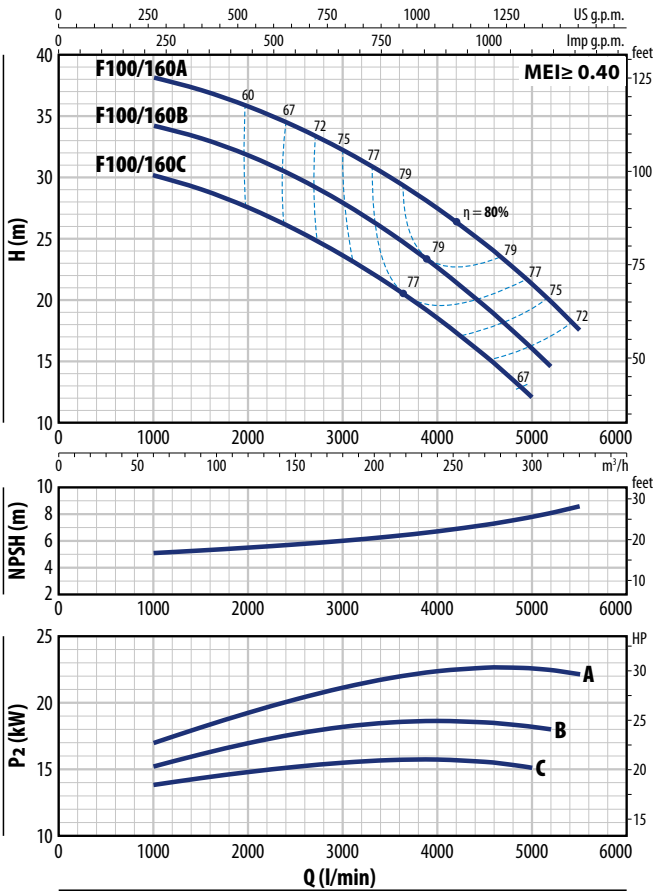

F 100/200

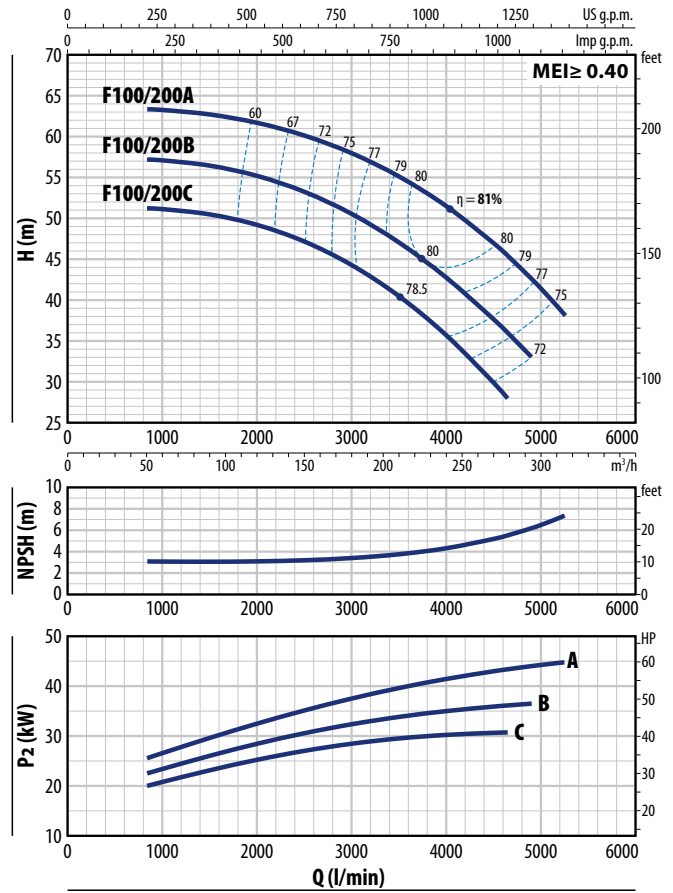

F 100/160

TYPE	POWER (P ₂)		3~	Q	m ³ /h														
	kW	HP			0	50	96	150	180	210	240	270	300	312	330				
Three-phase	kW	HP		l/min	1000	1500	2000	2500	3000	3500	4000	4500	5000	5200	5500				
F 100/160C	15	20	IE3	H metres	30	29	27.5	25.5	23.5	21	18.5	15.5	12						
F 100/160B	18.5	25			34	33	31.5	30	28	25.5	22.5	19.5	16	14.5					
F 100/160A	22	30			38	37	36	34	32	30	27.5	24.5	21	20	17.5				

F 100/200

TYPE	POWER (P ₂)		3~	Q	m ³ /h														
	kW	HP			0	50	96	150	180	210	240	279	294	300	315				
Three-phase	kW	HP		l/min	0	833	1600	2500	3000	3500	4000	4650	4900	5000	5250				
F 100/200C	30	40	IE3	H metres	51	51	50	47	44	40.5	35.5	28							
F 100/200B	37	50			57	57	56	53	50.5	47	42.5	36	33						
F 100/200A	45	60			63	63	62.5	60	58	55	51.5	45	42.5	41.5	38				

Q = Flow rate H = Total manometric head HS = Suction height

Performance curves comply with EN ISO 9906 Grade 3B tolerance limits.

F 100/250

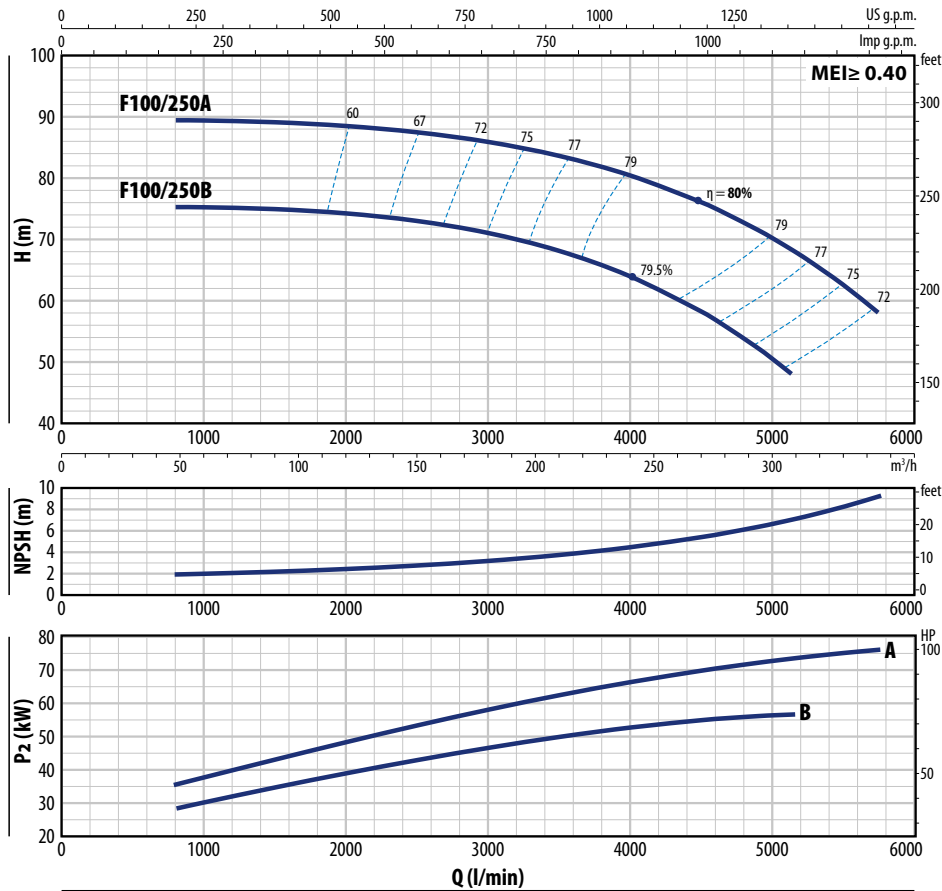

F 100/250

TYPE	POWER (P ₂)		3~	Q	48	96	150	180	210	240	300	309	345
	kW	HP			l/min	800	1600	2500	3000	3500	4000	5000	5150
F 100/250B	55	75	IE3	H metres	75	75	73	71	68	64	50.5	48	
F 100/250A	75	100			89	89	87.5	86	83.5	80.5	70	68	58

Q = Flow rate H = Total manometric head HS = Suction height

Performance curves comply with EN ISO 9906 Grade 3B tolerance limits.

ABSORPTION

TYPE	VOLTAGE
Single-ph.	230 V
Fm 32/160C	11.0 A
Fm 32/160B	12.0 A
Fm 40/125C	8.0 A
Fm 40/125B	10.0 A
Fm 40/160C	15.0 A
Fm 50/125C	13.5 A

TYPE	VOLTAGE			
	230 V - Δ	400 V - 人	400 V - Δ	690 V - 人
Three-phase				
F 32/160C	7.4 A	4.3 A	-	-
F 32/160B	8.6 A	5.0 A	-	-
F 32/160A	12.1 A	7.3 A	-	-
F 32/200C	17.8 A	10.3 A	-	-
F 32/200B	-	-	11.7 A	6.8 A
F 32/200A	-	-	14.9 A	8.6 A
F 32/200BH	12.6 A	7.3 A	-	-
F 32/200AH	15.4 A	8.9 A	-	-
F 32/250C	-	-	18.5 A	10.7 A
F 32/250B	-	-	22.0 A	12.7 A
F 32/250A	-	-	25.0 A	14.5 A
F 40/125C	5.2 A	3.0 A	-	-
F 40/125B	7.7 A	4.5 A	-	-
F 40/125A	9.0 A	5.2 A	-	-
F 40/160C	9.9 A	5.7 A	-	-
F 40/160B	12.6 A	7.3 A	-	-
F 40/160A	17.1 A	9.9 A	-	-
F 40/200B	-	-	12.6 A	7.3 A
F 40/200A	-	-	15.6 A	9.0 A
F 40/250C	-	-	21.0 A	12.1 A
F 40/250B	-	-	23.5 A	13.6 A
F 40/250A	-	-	30.5 A	17.6 A
F 50/125C	9.3 A	5.4 A	-	-
F 50/125B	13.1 A	7.6 A	-	-
F 50/125A	16.3 A	9.4 A	-	-
F 50/160C	15.7 A	9.1 A	-	-
F 50/160B	-	-	12.3 A	7.1 A
F 50/160A	-	-	15.5 A	9.0 A
F 50/200C	-	-	23.0 A	13.3 A
F 50/200B	-	-	29.5 A	17.1 A
F 50/200A	-	-	34.5 A	19.9 A
F 50/200AR	-	-	41.5 A	24.0 A

TYPE	VOLTAGE			
	230 V - Δ	400 V - 人	400 V - Δ	690 V - 人
Three-phase				
F 50/250D	-	19.0 A	19.0 A	11.0 A
F 50/250C	-	21.0 A	21.0 A	12.1 A
F 50/250B	-	27.0 A	27.0 A	15.6 A
F 50/250A	-	34.0 A	34.0 A	19.7 A
F 50/250AR	-	41.0 A	41.0 A	23.7 A
F 65/125C	17.3 A	10.0 A	-	-
F 65/125B	-	12.0 A	12.0 A	6.9 A
F 65/125A	-	16.5 A	16.5 A	9.5 A
F 65/160C	-	19.0 A	19.0 A	11.0 A
F 65/160B	-	23.0 A	23.0 A	13.3 A
F 65/160A	-	27.5 A	27.5 A	15.9 A
F 65/200B	-	30.0 A	30.0 A	17.3 A
F 65/200A	-	34.0 A	34.0 A	19.7 A
F 65/200AR	-	41.0 A	41.0 A	23.7 A
F 65/250C	-	53.0 A	53.0 A	30.6 A
F 65/250B	-	65.0 A	65.0 A	37.6 A
F 65/250A	-	79.0 A	79.0 A	45.7 A
F 80/160D	-	22.0 A	22.0 A	12.7 A
F 80/160C	-	29.0 A	29.0 A	16.8 A
F 80/160B	-	34.5 A	34.5 A	19.9 A
F 80/160A	-	39.0 A	39.0 A	22.5 A
F 80/200B	-	53.0 A	53.0 A	30.6 A
F 80/200A	-	65.0 A	65.0 A	37.6 A
F 80/250B	-	79.0 A	79.0 A	45.7 A
F 80/250A	-	98.0 A	98.0 A	56.6 A
F 100/160C	-	27.5 A	27.5 A	15.9 A
F 100/160B	-	32.5 A	32.5 A	18.8 A
F 100/160A	-	39.8 A	39.8 A	23.0 A
F 100/200C	-	53.0 A	53.0 A	30.6 A
F 100/200B	-	65.0 A	65.0 A	37.6 A
F 100/200A	-	79.0 A	79.0 A	45.7 A
F 100/250B	-	98.0 A	98.0 A	56.6 A
F 100/250A	-	126.0 A	126.0 A	72.8 A

MATERIALS AND COMPONENTS

1 Pump body	Cast iron, fitted with inlet and outlet flanged ports			
2 Cover/Motor bracket	Cast iron			
3 Impeller	Brass	for F32/160 - F32/200 - F40/125 - F40/160 - F40/200 - F50/125 - F50/160		
	Cast iron	for F32/250 - F40/250 - F50/200 - F50/250 - F65/125 - F65/160 - F65/200 - F65/250 F80/160 - F80/200 - F80/250 - F100/160 - F100/200 - F100/250		
4 Mechanical seal	Water pump	Seal	Shaft	Materials
	F32/160 - F40/125 - F40/160 - F50/125	FN-20	Ø 20 mm	Graphite Ceramic NBR
	F32/200 - F40/200 - F50/160 - F65/125	FN-24	Ø 24 mm	
	F50/200 - F65/160 - F65/200 - F80/160 - F100/160	FN-32 NU	Ø 32 mm	
	F32/250 - F40/250 - F50/250	FN-38	Ø 38 mm	
	F65/250 - F80/200 - F80/250B - F100/200	FN-40 NU	Ø 40 mm	
	F80/250A - F100/250	FH-45 NU	Ø 45 mm	
5 Motor shaft	Stainless steel AISI 431			
6 Electric motor	<p>Fm: single-phase 230 V - 50 Hz with winding integrated thermal motor protection (up to 1.5 kW)</p> <p>F: three-phase 230/400 V 50 Hz up to 4 kW - 400/690 V 50 Hz from 5.5 to 75 kW</p> <p>※ Pumps are equipped with high-efficiency motors (IEC 60034-30-1)</p> <p>class IE2 for single-phase models</p> <p>class IE3 for three-phase models</p> <p>Continuous running duty S1</p>			

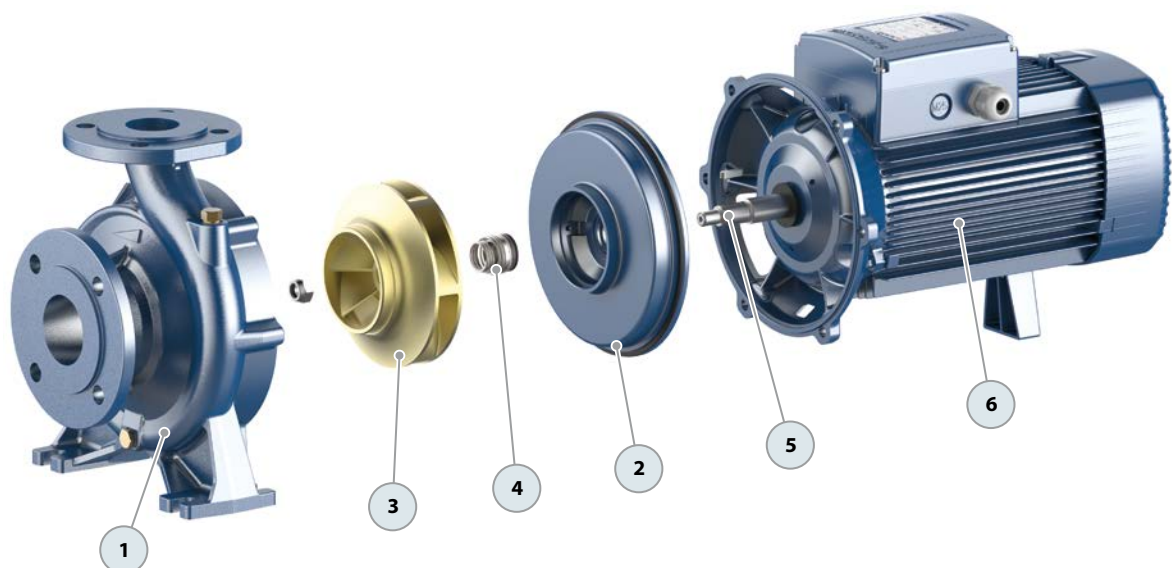

DIMENSIONS AND WEIGHT

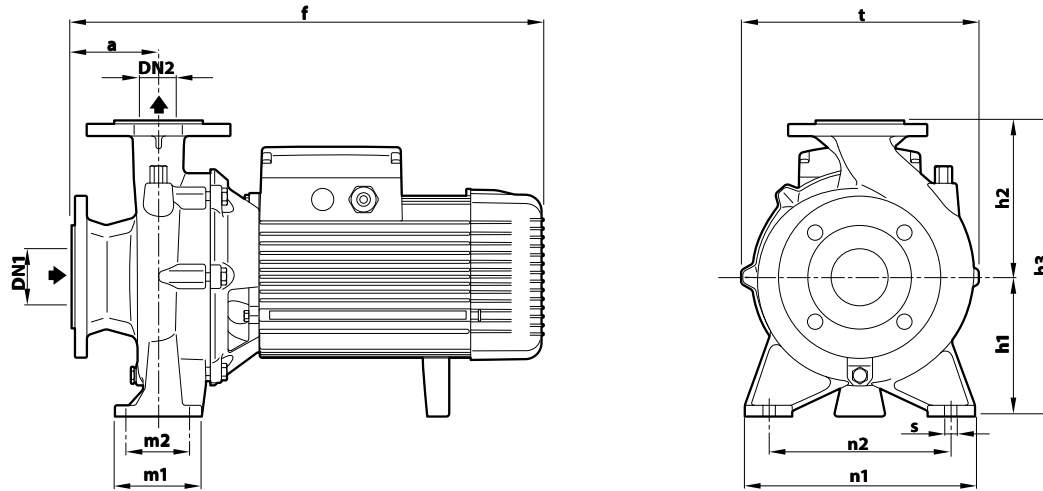

TYPE		PORTS		DIMENSIONS mm											kg										
Single-ph.	Three-ph.	DN1	DN2	a	f	h1	h2	h3	t	n1	n2	m1	m2	s	1~	3~									
Fm 32/160C	F 32/160C	50	32	80	416	160	180	273	240	245	190	100	70	14	32.6	32.5									
Fm 32/160B	F 32/160B				436										35.3	36.0									
-	F 32/160A				473										-	39.0									
-	F 32/200C				478										-	46.0									
-	F 32/200B				528										-	50.0									
-	F 32/200A				478										-	57.0									
-	F 32/200BH				478										-	41.7									
-	F 32/200AH			100	659	180	225	405	325	320	250	125	95		-	45.0									
-	F 32/250C			-	-	-	-	-	-	-	-	-	-		-	-	-	105.0							
-	F 32/250B			-	-	-	-	-	-	-	-	-	-		-	-	-	103.3							
-	F 32/250A			-	-	-	-	-	-	-	-	-	-		-	-	-	121.0							
Fm 40/125C	F 40/125C			65	40	80	421	140	180	277	244	210	160		100	70	14	31.5	31.0						
Fm 40/125B	F 40/125B						441											33.0	32.4						
-	F 40/125A						435											-	35.3						
Fm 40/160C	F 40/160C	473	35.3				36.0																		
-	F 40/160B	498	-				36.1																		
-	F 40/160A	548	-				43.0																		
-	F 40/200B	498	-				52.4																		
-	F 40/200A	548	-			59.0																			
-	F 40/250C	659	180			225	405	329	320	250	125	95	-	105.0											
-	F 40/250B	-	-			-	-	-	-	-	-	-	-	-	105.0										
-	F 40/250A	-	-			-	-	-	-	-	-	-	-	-	128.5										
Fm 50/125C	F 50/125C	65	50			100	455	160	180	273	242	240	190	100	70	14		34.4	35.1						
-	F 50/125B						493											-	35.2						
-	F 50/125A						498											-	42.0						
-	F 50/160C			548	-		45.5																		
-	F 50/160B			669	160		180										340	273	265	212	100	70	-	51.0	
-	F 50/160A			769	-		57.0																		
-	F 50/200C			769	-		100.0																		
-	F 50/200B			769	-	114.0																			
-	F 50/200A			768.5	200	360	316.5	-	-	-	-	-	-	127.0											
-	F 50/200AR			-	-	-	-	-	-	-	-	-	-	-	143.0										
-	F 50/250D			-	-	-	-	-	-	-	-	-	-	-	105.0										
-	F 50/250C			659	180	225	405	333	320	250	-	-	-	-	108.0										
-	F 50/250B			-	-	-	-	-	-	-	-	-	-	-	121.0										
-	F 50/250A			759	-	-	-	-	-	-	-	-	-	-	134.0										
-	F 50/250AR	-	-	-	-	-	-	-	-	-	-	-	149.0												
-	F 65/125C	80	65	125	520	180	225	336	292	280	212	125	95	14	-	53.4									
-	F 65/125B				570										-	58.0									
-	F 65/125A				674										-	64.0									
-	F 65/160C				674										200	360	295	-	-	-	-	-	-	-	100.0
-	F 65/160B				676										-	112.0									
-	F 65/160A				776										-	119.3									
-	F 65/200B				776										-	132.0									
-	F 65/200A			-	-	-	-	-	-	-	-	-	-		-	147.0									
-	F 65/200AR			-	-	-	-	-	-	-	-	-	-		-	147.0									
-	F 80/160D			100	80	125	705	180	225	405	320	250	-		-	-	-	104.0							
-	F 80/160C						805	-	121.0																
-	F 80/160B						818	200	280	480	382	360	280		160	120	18	-	133.0						
-	F 80/160A						818	-	145.0																
-	F 100/160C			125	100	125	718	-	-	-	-	-	-		-	-	-	141.2							
-	F 100/160B	818	-				155.0																		
-	F 100/160A	818	-				165.0																		

DIMENSIONS AND WEIGHT

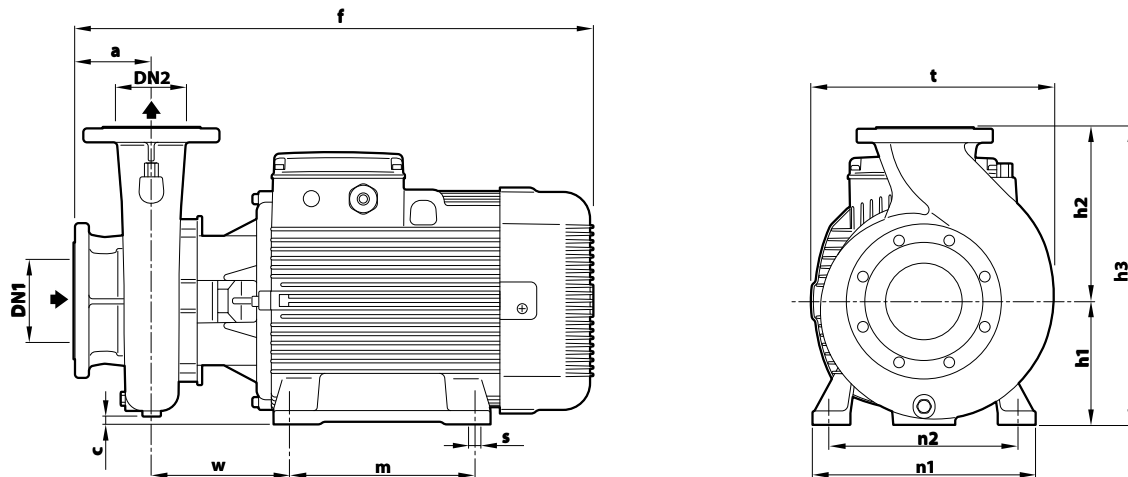

TYPE	PORTS		DIMENSIONS mm											kg 3~	
	DN1	DN2	a	f	h1	h2	h3	c	t	n1	n2	w	m		s
Three-ph.															
F 65/250C	80	65	100	809	200	250	450	15	377	360	318	214.5	305	19	211.0
F 65/250B															225.0
F 65/250A															239.0
F 80/200B	100	80	125	837	200	250	450	25	372	360	318	217.5	305	19	203.0
F 80/200A															218.0
F 80/250B															249.0
F 80/250A															547.0
F 100/200C	125	100	125	839	200	280	480	-	395	360	318	219.5	305	19	217.0
F 100/200B															231.0
F 100/200A															245.0
F 100/250B															551.2
F 100/250A															544.3

PORT FLANGES

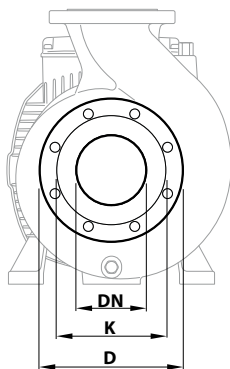

DN FLANGE mm	D mm	K mm	HOLES	
			N°	Ø (mm)
32	140	100	4	18
40	150	110		
50	165	125		
65	185	145		
80	200	160		
100	220	180	8	
125	250	210		

COUNTER-FLANGE

(CAN BE ORDERED SEPARATELY)

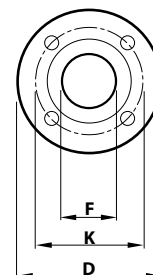

DN FLANGE mm	F COUNTER-FLANGE	D mm	K mm	HOLES	
				N°	Ø (mm)
32	1¼"	140	100	4	18
40	1½"	150	110		
50	2"	165	125		
65	2½"	185	145		
80	3"	200	160		
100	4"	220	180	8	
125	5"	250	210		