



# LumiPlus Mini Spa projector

The Mini LED projector is a small underwater floodlight ideal for lighting a pool's steps and/or corners.

It is available in cool white, warm white and RGB multicolor light.

The multicolor versions are compatible with the ECO, TOP, LumiPlus LED app, ModBUS (Connect) and DMX controllers (see codes).

There is a choice of several types of faceplate: ABS (white, gray, anthracite and beige) and AISI 316 stainless steel.

Designed for installation in spas with a 2" thread.







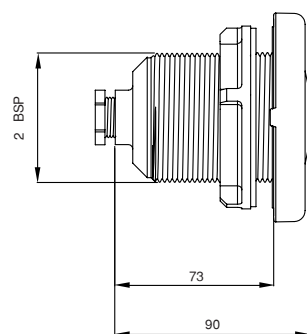
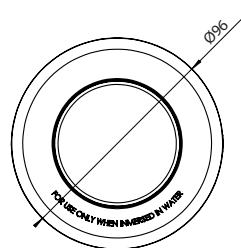





## TECHNICAL SPECIFICATIONS

VOLTAGE:	12 V AC (24 V DC in DMX version)
FREQUENCY:	50/60 Hz
SERVICE LIFE:	L70-50,000 h
MAX. WATER TEMPERATURE:	40 °C
MAX. INSTALLATION DEPTH:	2 m.
MAXIMUM WATER TREATMENT VALUES:	Chlorine: 2 mg/l Bromine: 5 mg/l Salt chlorinator (NaCl): 6 g/l Pool water pH: 7.2 and 7.6
CABLE	2.5 m. H07RN-F 2 x 1 mm <sup>2</sup>
MATERIALS:	Chrome-plated brass body ABS/AISI 316 stainless steel
Faceplate available in:	Beige: 08554-0500CL090 Light gray: 08554-0500CL129 Anthracite: 08554-0500CL144



\* measurements in mm.

	52126	52127	52132	52132WW	52133	52133WW	52138	52139
FACEPLATE MATERIAL	ABS	AISI 316	ABS	ABS	AISI 316	AISI 316	ABS	AISI 316
TYPE OF LIGHT	RGB 	RGB 	WHITE	WARM WHITE	WHITE	WARM WHITE	RGB DMX	RGB DMX
POWER	4 W	4 W	4 W	4 W	4 W	4 W	4 W	4 W
CONSUMPTION	7 VA	7 VA	6 VA	6 VA	6 VA	6 VA	4 VA	4 VA
LUMINOUS FLUX	186 lm	186 lm	315 lm	315 lm	315 lm	315 lm	186 lm	186 lm
VOLTAGE	12 V AC	12 V AC	12 V AC	12 V AC	12 V AC	12 V AC	24 V DC	24 V DC
COLOR TEMP.	-	-	5,700 K	3,000 K	5,700 K	3,000 K	-	-
CRI >	-	-	70	80	70	80	-	-
LUMINOUS EFFICIENCY	46.5 lm/W	46.5 lm/W	78.75 lm/W	78.75 lm/W	78.75 lm/W	78.75 lm/W	46.5 lm/W	46.5 lm/W
FLUX ANGLE	35°	35°	35°	35°	35°	35°	35°	35°
LENS	Wide	Wide	Wide	Wide	Wide	Wide	Wide	Wide
THERMAL PROTECTION	Flasher	Flasher	No	No	No	No	Self-regulation	Self-regulation
ENERGY CLASS As per UE 2019/2015								
INSTALLATION IN SALT WATER	No	No	No	No	No	No	No	No
COMPATIBLE CONTROL SYSTEMS	32458, 27818, 41988, 59131, 57434	32458, 27818, 41988, 59131, 57434	ON/OFF	ON/OFF	ON/OFF	ON/OFF	52142, 74099, 74100	52142, 74099, 74100

 Fluidra Connect compatible

## PHOTOMETRIC MEASUREMENTS

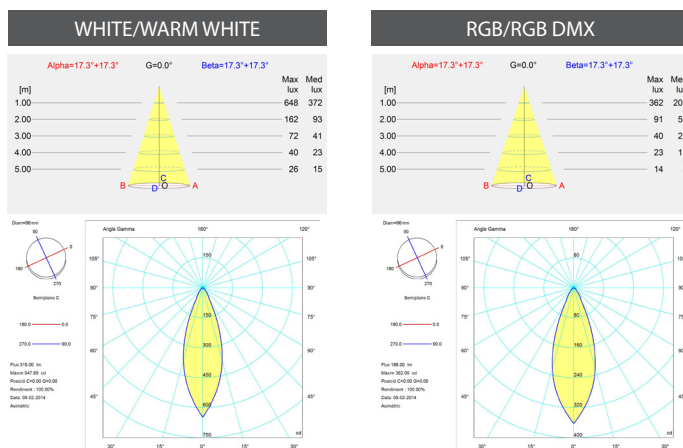

## PACKAGING AND PALLETIZATION

Volume/Single box (m <sup>3</sup> )	0.004
Weight/Single box (kg)	1.350
Units/Standard box	4
Volume/Standard box (m <sup>3</sup> )	0.022
Weight/Standard box (kg)	5.895
Units/Pallet	192
Volume/Pallet (m <sup>3</sup> )	2.304
Weight/Pallet (kg)	313.96

