



LumiPlus Design projector

The LumiPlus Design projector is an underwater high-power floodlight that can be fitted on niches 180 mm in diameter.

The faceplate is available in a stainless steel effect and pure white finish.

It is available in cool white, warm white and RGB multicolor light. The multicolor versions are compatible with the ECO, TOP, wireless, LumiPlus LED app, ModBUS (Connect) and DMX controllers (see codes).



reddot award







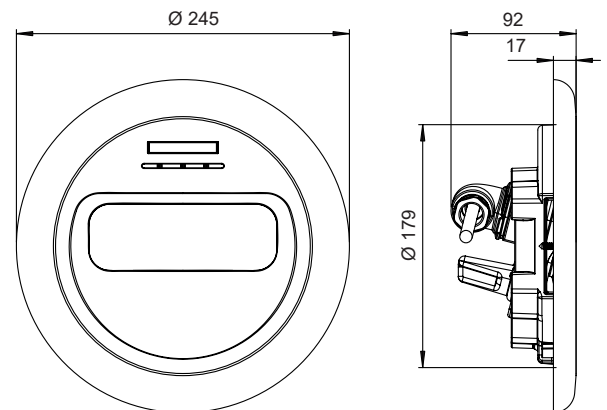



TECHNICAL SPECIFICATIONS

VOLTAGE:	12 V AC
FREQUENCY:	50/60 Hz
SERVICE LIFE:	L70-50,000 h
MAX. WATER TEMPERATURE:	40 °C
MAX. INSTALLATION DEPTH:	2 m.
MAXIMUM WATER TREATMENT VALUES:	Chlorine: 2 mg/l Bromine: 5 mg/l Salt chlorinator (NaCl): 6 g/l Pool water pH: 7.2 and 7.6
CABLE	2.5 m. H07RN-F 2 x 1.5mm ²
MATERIALS:	PPS and PA body ABS + IMD faceplate
COMPATIBLE ACCESSORIES AND NICHES:	59813, 59814, 59815, 59818 *

* Compatible with most Ø180 to 190 mm niches in the market
(Hugo Lahme, MTS Productts, Wibre, etc.). Check with your dealer.



* measurements in mm.

	59801	59803	59805	59805WW	59807	59807WW	59809	59811
FACEPLATE FINISH	Stainless steel effect	Pure white	Stainless steel effect	Stainless steel effect	Pure white.	Pure white	Stainless steel effect	Pure white
TYPE OF LIGHT	RGB 	RGB 	WHITE	WARM WHITE	WHITE	WARM WHITE	RGB DMX	RGB DMX
POWER	32 W	32 W	32 W	32 W	32 W	32 W	32 W	32 W
CONSUMPTION	42 VA	42 VA	35 VA	35 VA	35 VA	35 VA	42 VA	42 VA
LUMINOUS FLUX	2,544 lm	2,544 lm	4,320 lm	4,320 lm	4,320 lm	4,320 lm	2,544 lm	2,544 lm
VOLTAGE	12 V AC	12 V AC	12 V AC	12 V AC	12 V AC	12 V AC	12 V AC	12 V AC
COLOR TEMP.	-	-	5,700 K	3,000 K	5,700 K	3,000 K	-	-
CRI >	-	-	70	80	70	80	-	-
LUMINOUS EFFICIENCY	80	80	135	135	135	135	80	80
FLUX ANGLE	120°	120°	120°	120°	120°	120°	120°	120°
LENS	Asymmetric	Asymmetric	Asymmetric	Asymmetric	Asymmetric	Asymmetric	Asymmetric	Asymmetric
THERMAL PROTECTION	Flasher	Flasher	Flasher	Flasher	Flasher	Flasher	Flasher	Flasher
ENERGY CLASS As per UE 2019/2015 								
INSTALLATION IN SALT WATER	Yes	Yes	Yes	Yes	Yes	Yes	Yes	Yes
COMPATIBLE CONTROL SYSTEMS	32458, 27818, 41988, 59131, 57434	32458, 27818, 41988, 59131, 57434	ON/OFF	ON/OFF	ON/OFF	ON/OFF	41107, 74099, 74100	41107, 74099, 74100

PHOTOMETRIC MEASUREMENTS

 Fluidra Connect compatible

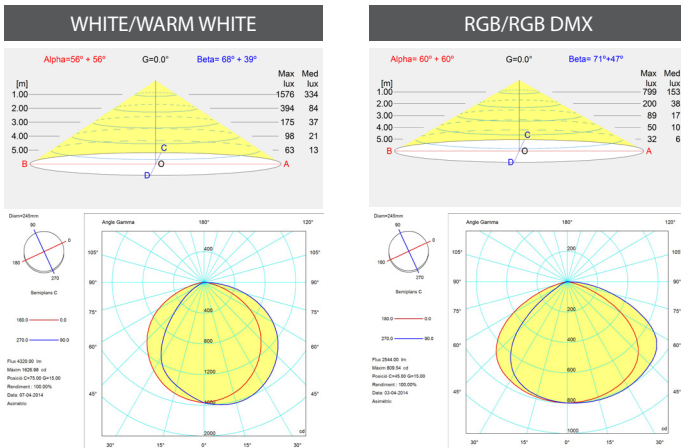

PACKAGING AND PALLETIZATION

Volume/Single box (m ³)	0.004
Weight/Single box (kg)	1.350
Units/Standard box	4
Volume/Standard box (m ³)	0.047
Weight/Standard box (kg)	5.895
Units/Pallet	144
Volume/Pallet (m ³)	2.160
Weight/Pallet (kg)	227.22

